

Föreläsning 11

Serieresonantkrets

Bandpassfilter

Bandspärrfilter

Andra ordnings filter

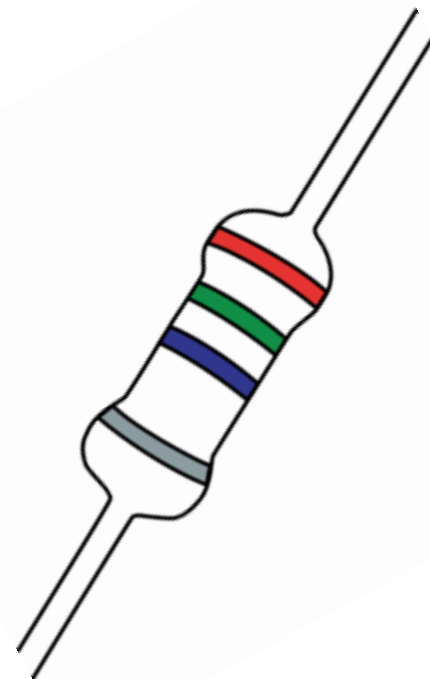

Överföringsfunktion - frekvensdomän



$$H(j\omega) = \frac{V_{ut}}{V_{in}} = |H|e^{j \arg(H)}$$

Amplitud: $|H|$

Fas: $\arg(H)$

$$v_{in}(t) = V_0 \cos(\omega t)$$

$$v_{ut}(t) = |H(\omega)|V_0 \cos(\omega t + \arg(H))$$

Decibel (dB)

$$|H|_{dB} = 20 \log_{10}(|H|)$$

$$|H|=1 \rightarrow |H|_{dB}=0$$

$$|H|=0.1 \rightarrow |H|_{dB}=-20 \text{ dB}$$

$$|H|=0.01 \rightarrow |H|_{dB}=-40 \text{ dB}$$

$$|H|=0.001 \rightarrow |H|_{dB}=-60 \text{ dB}$$

$$|H|=10 \rightarrow |H|_{dB}=20 \text{ dB}$$

$$|H|=1/\sqrt{2} \rightarrow |H|_{dB}=-3 \text{ dB}$$

$$\log(ab) = \log(a) + \log(b)$$

$$\log(a^b) = b \cdot \log(a)$$

Resonantkretsar

- Serieresonans
 - Bandpassfilter
 - Andra ordningens hög/lågpas

Ideala filtertyper

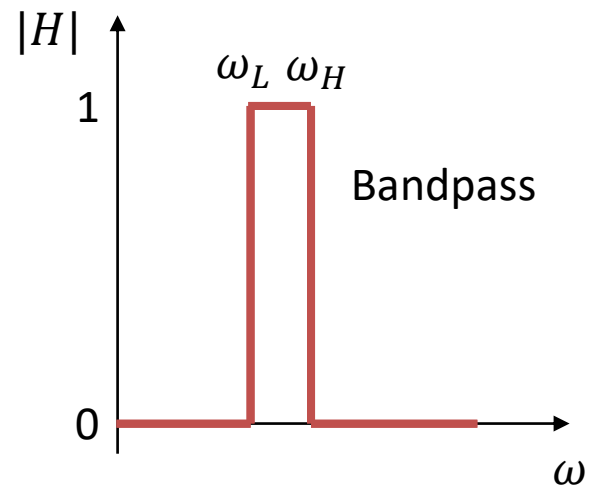
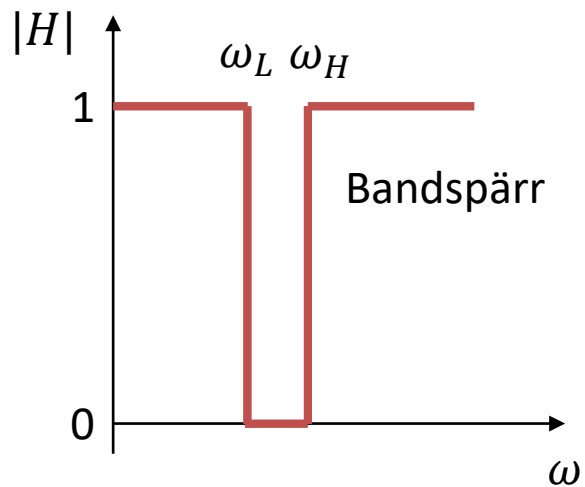
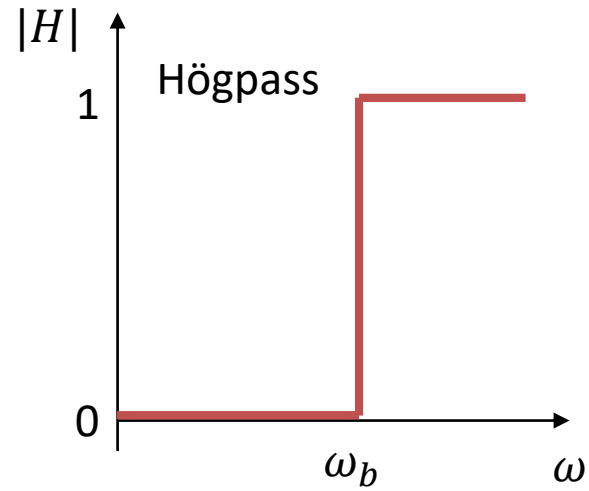
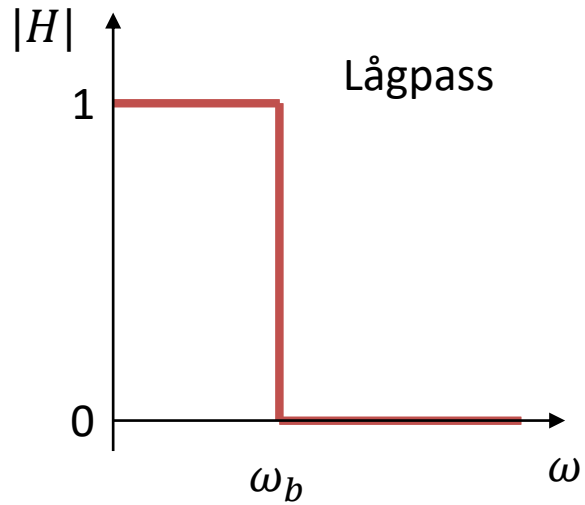

Bandpassfilter

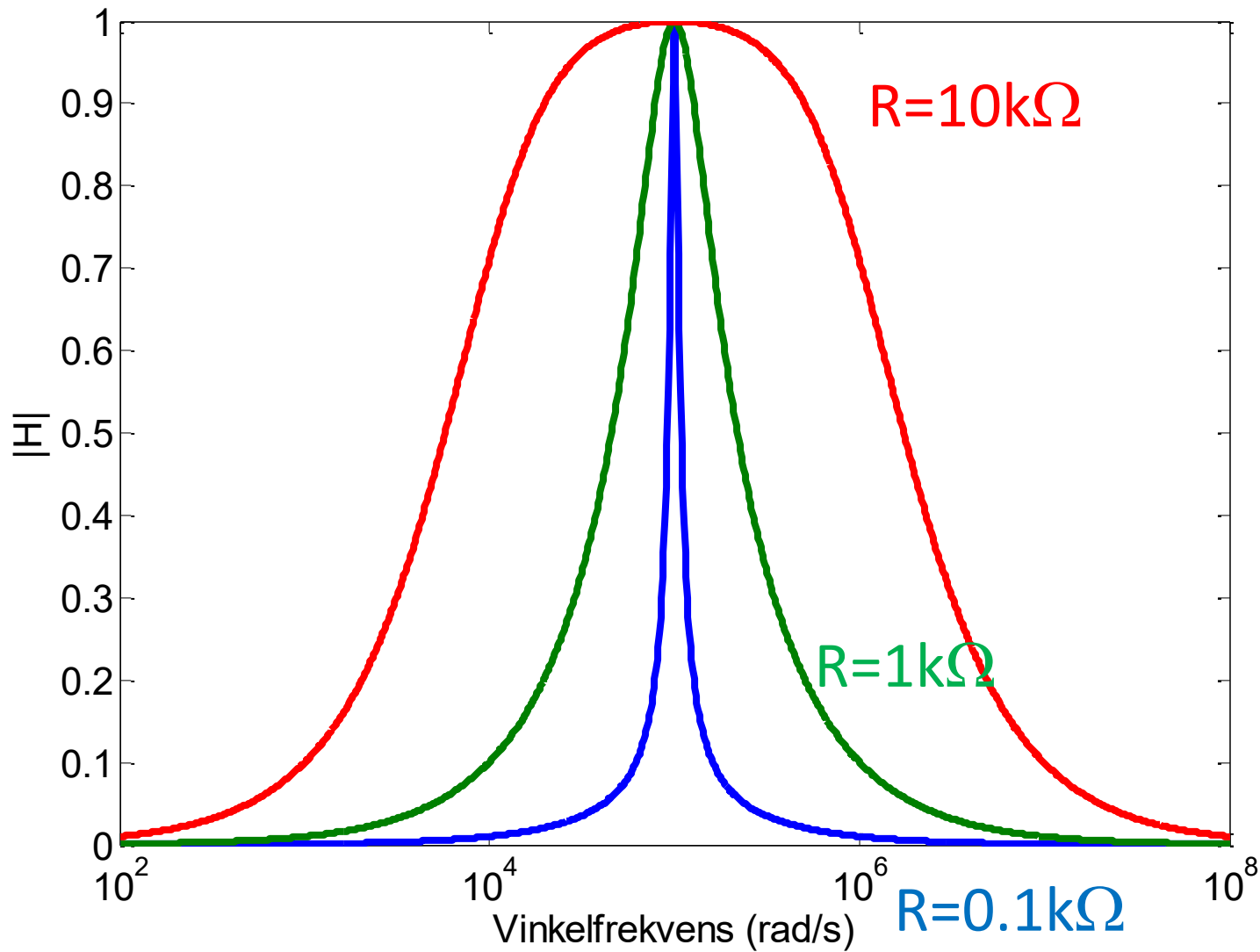

$L=10\text{ mH}$
 $C=10\text{ nF}$

Bandpassfilter

$f = 2.4 \text{ GHz}$



$f = 2.485 \text{ GHz}$



$f = 2.1 \text{ GHz}$



Bandpass vid 2.1 GHz



$f = 2.395 \text{ GHz}$

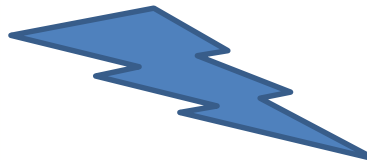

$f = 900 \text{ MHz}$



Filter (?)



Ett batteri på 1V kopplas in på en tvåport. Utgången mäter 0V.
Vilken typ av filter skulle tvåporten kunna vara?

- A) HögpPASS
- B) LågpPASS
- C) AllPASS
- D) ???

Nano.participoll.com



Bandspärrfilter

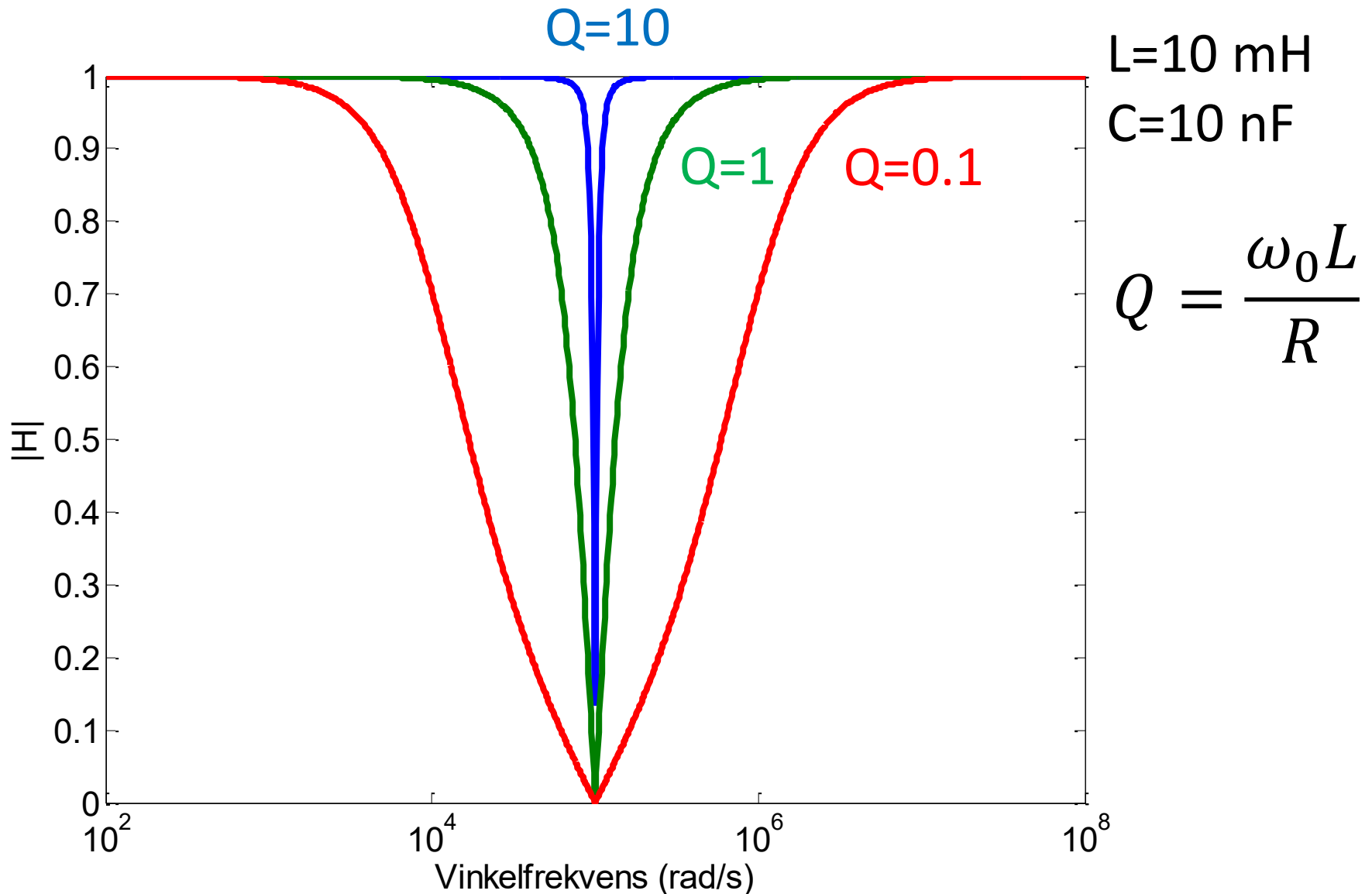

Bandspärrfilter



$f = 2.1 \text{ GHz}$



$f = 2.45 \text{ GHz}$



$f = 2.45 \text{ GHz}$



Andra ordningens lågpassfilter

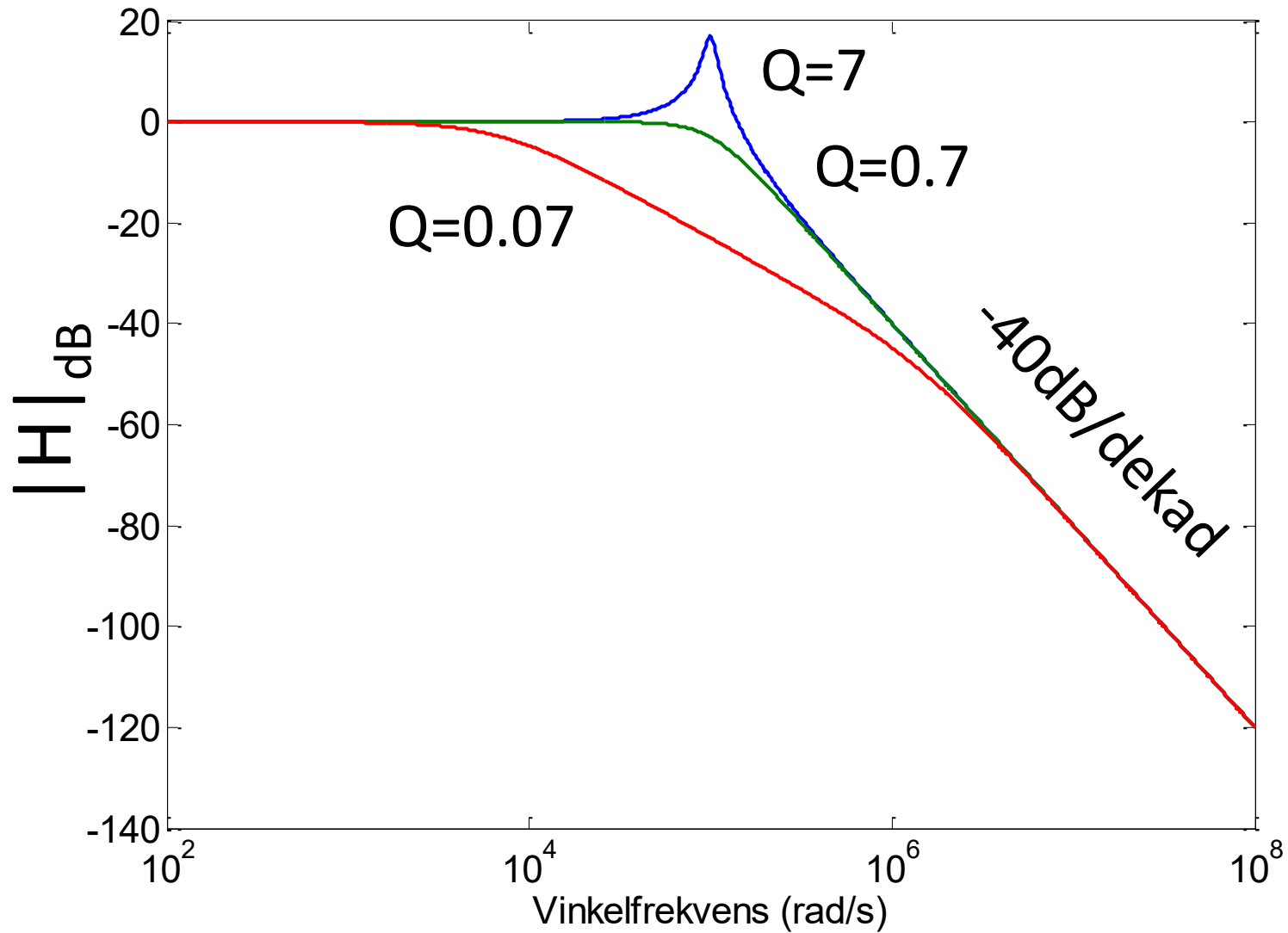

Andra ordningens lågpassfilter

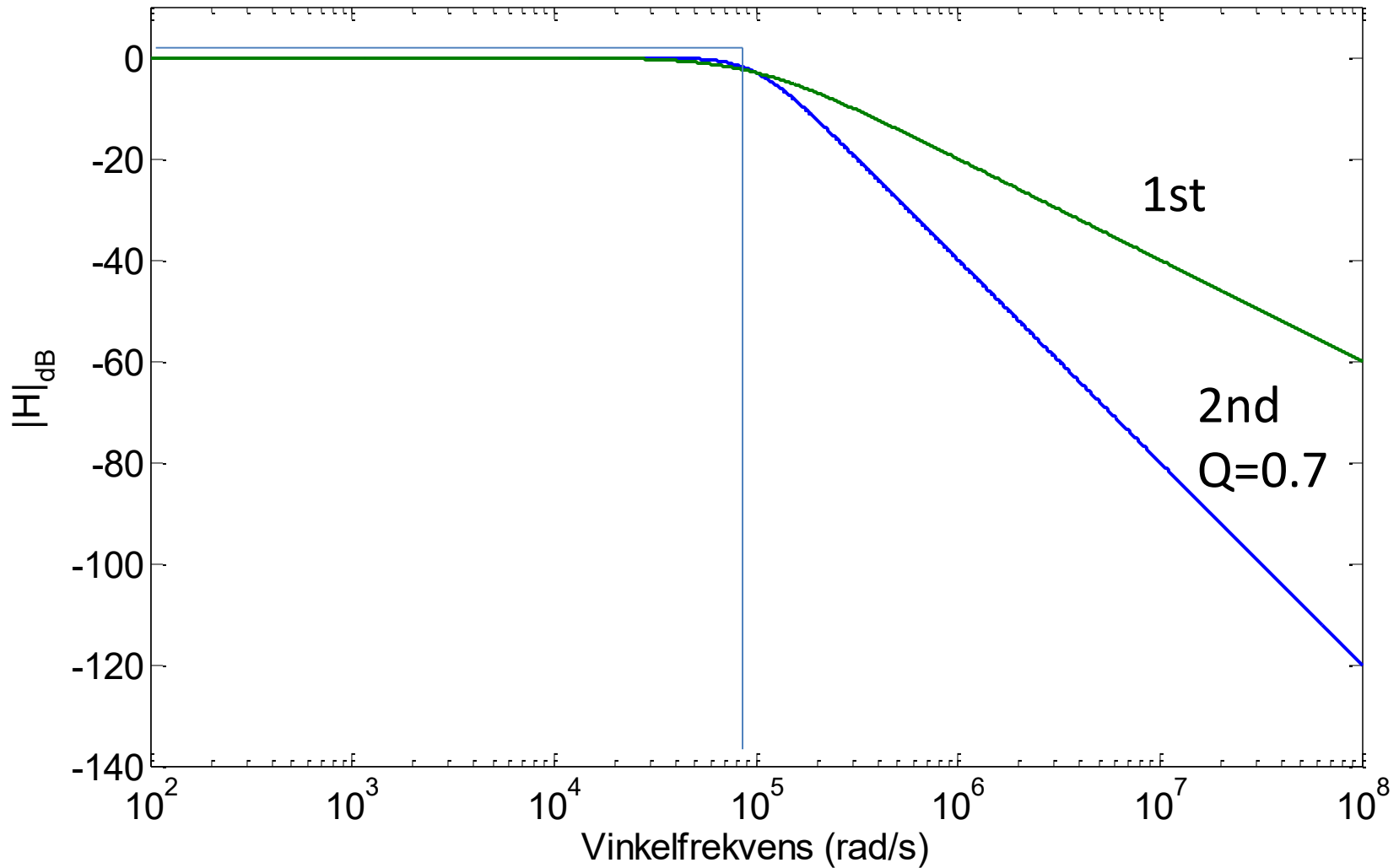

Andra ordningens lågpassfilter - resonans

$$v(t) = \begin{cases} 0, & t < 0 \\ V_0 \sin(\omega t), & t > 0 \end{cases}$$

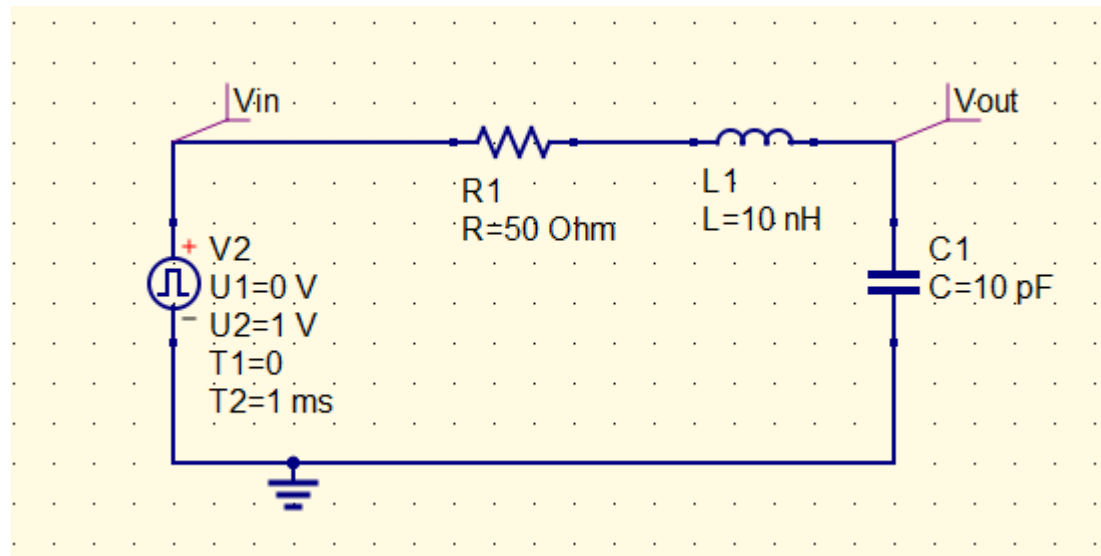

Andra ordningens lågpassfilter - resonans

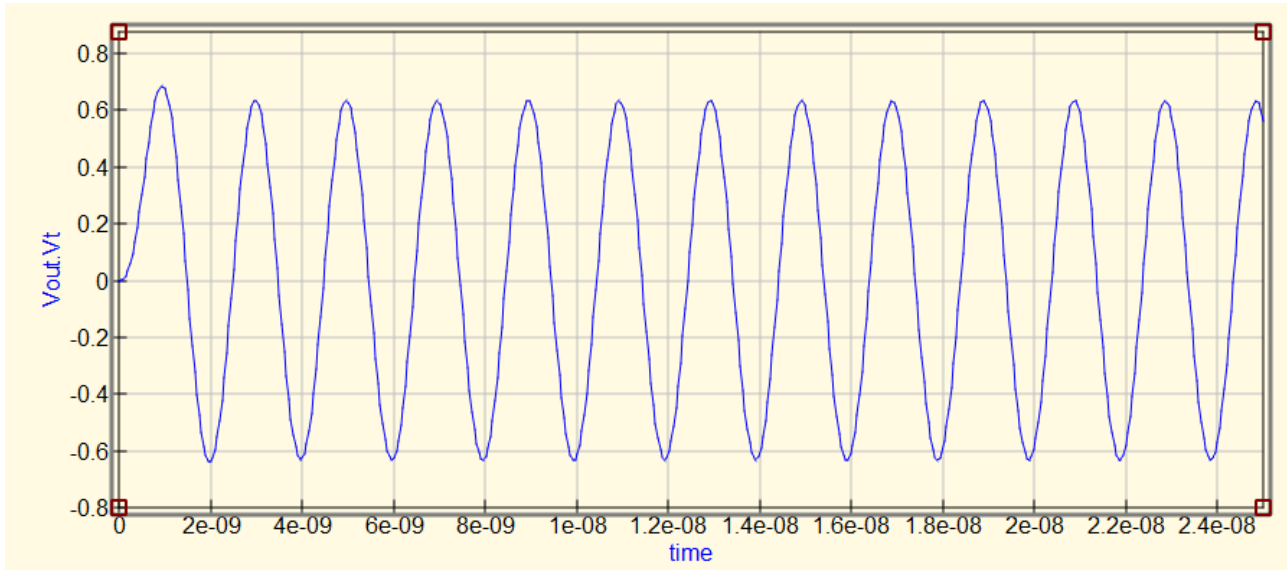

$$V_{in} = 1$$

$$Q_S \approx 0.63$$

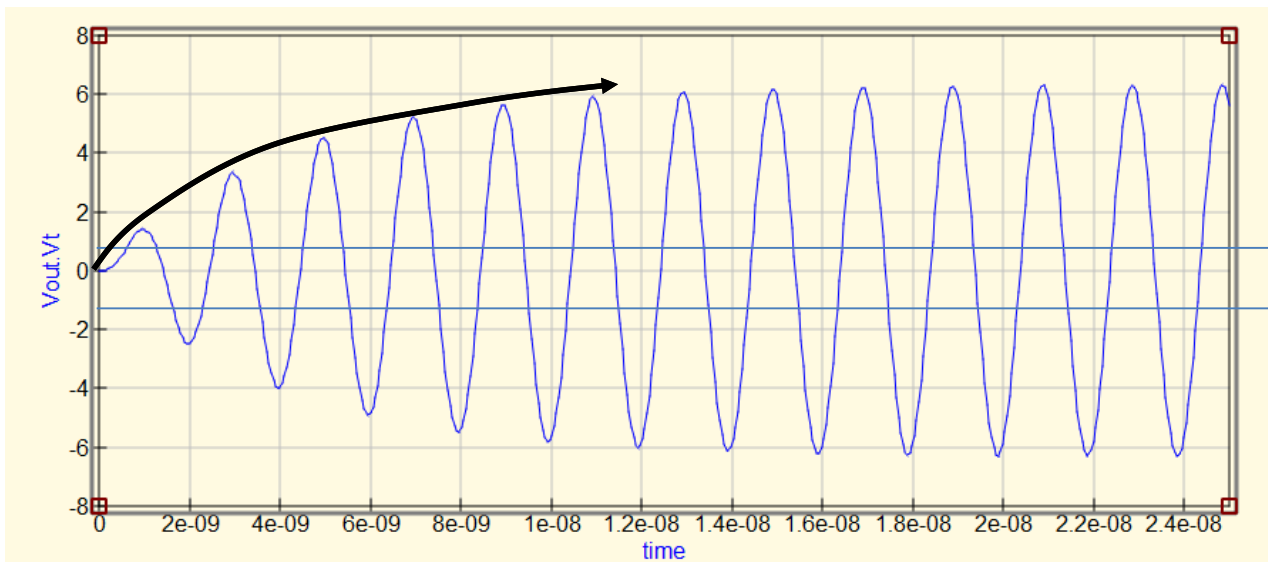

$$V_{in} = 1$$

$$Q_S \approx 6.3$$

$$|H| \approx 6.3$$

Vi behöver lär lösa den fulla differentialekvationen!

Resonans

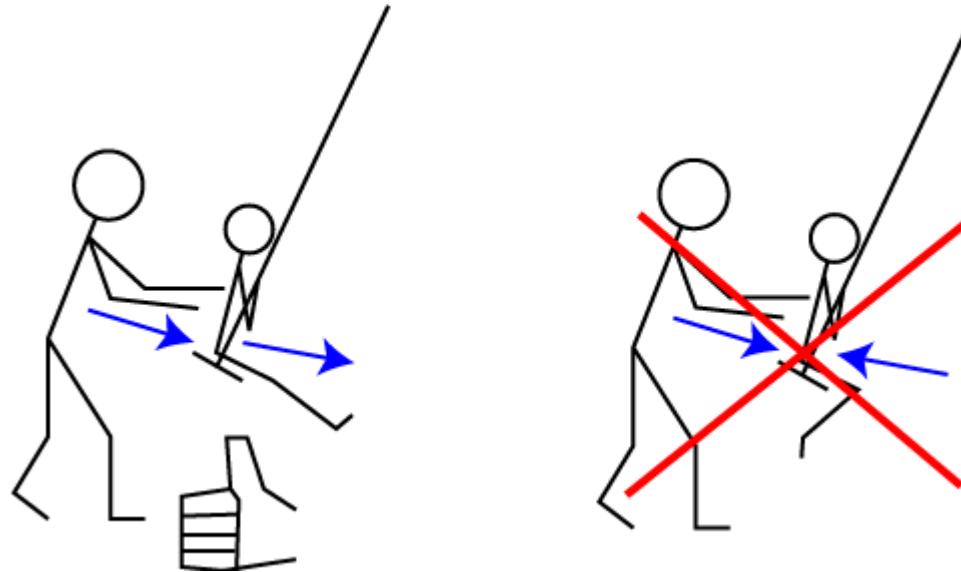

**Den lagrade energin i spolen / kondensatorn ökar successivt vid resonansfrekvensen.
Vid jämvikt – förlorad energi i resistorn bestämmer strömmen genom kretsen.**

Andra ordningens lågpassfilter – resonans - stegsvar

$$v(t) = \begin{cases} 0, & t < 0 \\ V_0, & t \geq 0 \end{cases}$$

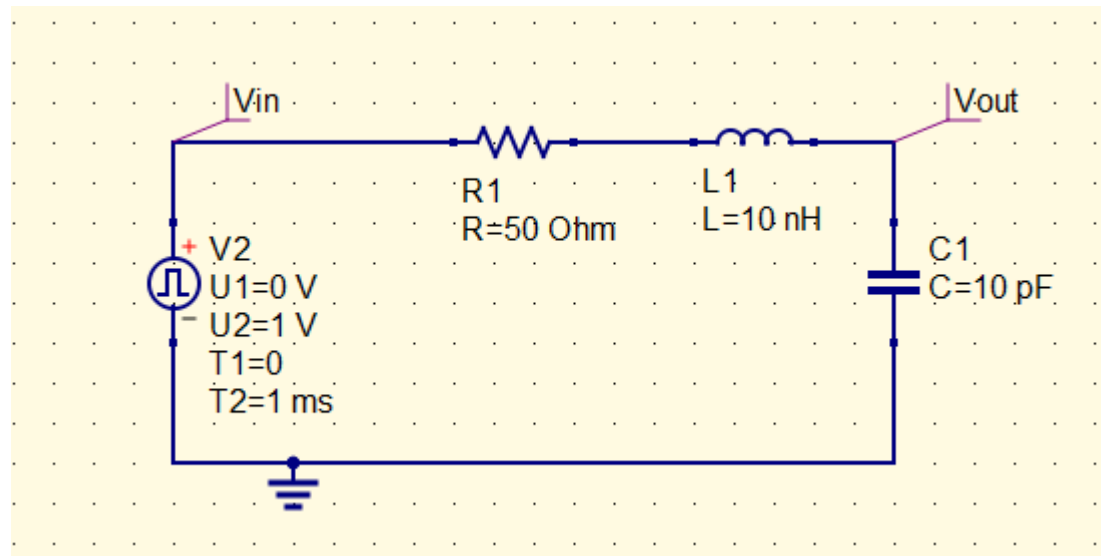

Andra ordningens lågpasfilter – resonans: stegsvar

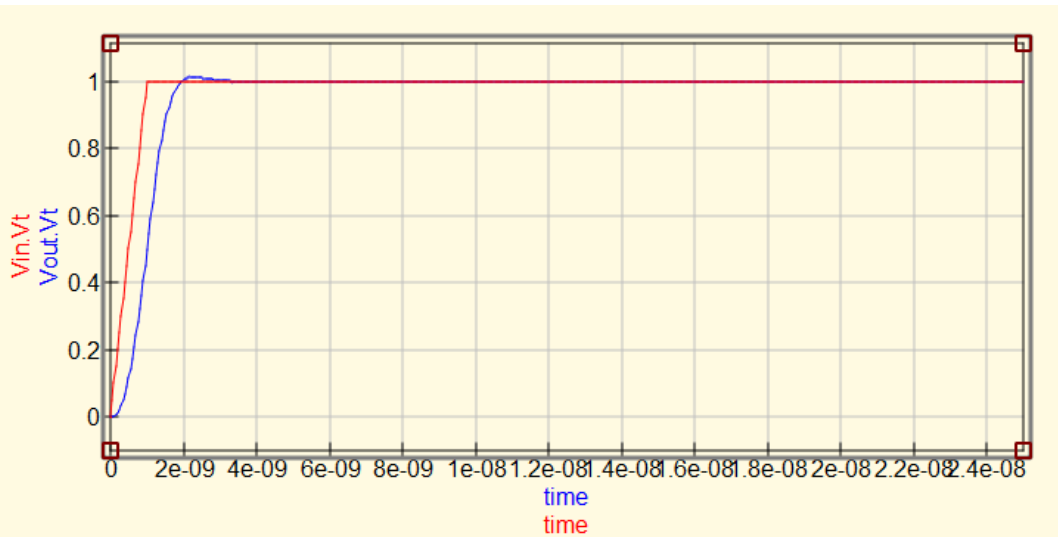

$$V_{in} = 1$$

$$Q_S \approx 0.63$$

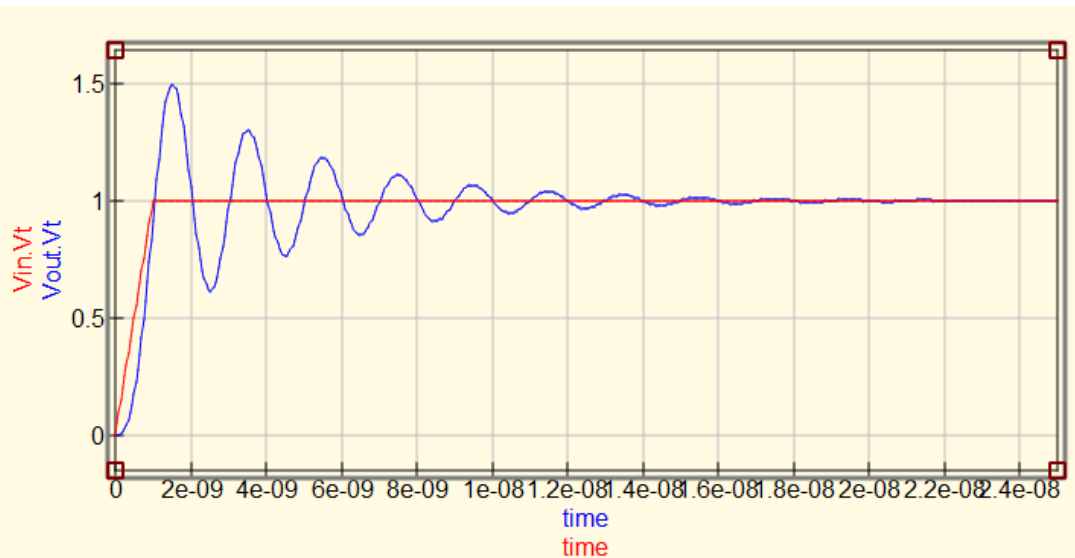

$$V_{in} = 1$$

$$Q_S \approx 6.3$$

Vi behöver här lösa den fulla differentialekvationen!

Sammanfattning Filter

- Ni behöver kunna första ordningen RC och RL högpas/lågpas filter.
- Konstruera lågpas och högpasfilter
- Förstå och bestämma brytfrekvens
- Kunna rita och läsa av Bode-diagram för RC och RL
- Förstå och kunna räkna med decibel
- Förstå serieresonanskretsar.