

LM2940/LM2940C

1A Low Dropout Regulator

General Description

The LM2940/LM2940C positive voltage regulator features the ability to source 1A of output current with a dropout voltage of typically 0.5V and a maximum of 1V over the entire temperature range. Furthermore, a quiescent current reduction circuit has been included which reduces the ground current when the differential between the input voltage and the output voltage exceeds approximately 3V. The quiescent current with 1A of output current and an input-output differential of 5V is therefore only 30 mA. Higher quiescent currents only exist when the regulator is in the dropout mode ($V_{IN} - V_{OUT} \leq 3V$).

Designed also for vehicular applications, the LM2940/LM2940C and all regulated circuitry are protected from reverse battery installations or 2-battery jumps. During line transients, such as load dump when the input voltage can

momentarily exceed the specified maximum operating voltage, the regulator will automatically shut down to protect both the internal circuits and the load. The LM2940/LM2940C cannot be harmed by temporary mirror-image insertion. Familiar regulator features such as short circuit and thermal overload protection are also provided.

Features

- Dropout voltage typically 0.5V @ $I_O = 1A$
- Output current in excess of 1A
- Output voltage trimmed before assembly
- Reverse battery protection
- Internal short circuit current limit
- Mirror image insertion protection
- P+ Product Enhancement tested

Typical Application

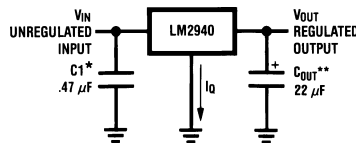

DS008822-3

*Required if regulator is located far from power supply filter.

** C_{OUT} must be at least 22 μF to maintain stability. May be increased without bound to maintain regulation during transients. Locate as close as possible to the regulator. This capacitor must be rated over the same operating temperature range as the regulator and the ESR is critical; see curve.

Ordering Information

Temperature Range	Output Voltage						Package
	5.0	8.0	9.0	10	12	15	
$0^\circ C \leq T_A \leq 125^\circ C$	LM2940CT-5.0 LM2940CS-5.0		LM2940CT-9.0 LM2940CS-9.0		LM2940CT-12 LM2940CS-12	LM2940CT-15 LM2940CS-15	TO-220 TO-263
$-40^\circ C \leq T_A \leq 125^\circ C$	LM2940T-5.0 LM2940S-5.0	LM2940T-8.0 LM2940S-8.0	LM2940T-9.0 LM2940S-9.0	LM2940T-10 LM2940S-10	LM2940T-12 LM2940S-12		TO-220 TO-263
$-40^\circ C \leq T_A \leq 85^\circ C$	LM2940IMP-5.0	LM2940IMP-8.0	LM2940IMP-9.0	LM2940IMP-10	LM2940IMP-12	LM2940IMP-15	SOT-223
SOT-223 Package Marking	L53B	L54B	L0EB	L55B	L56B	L70B	

The physical size of the SOT-223 is too small to contain the full device part number. The package markings indicated are what will appear on the actual device.

Temperature Range	Output Voltage				Package
	5.0	8.0	12	15	
$-55^\circ C \leq T_A \leq 125^\circ C$	LM2940J-5.0/883 5962-8958701EA	LM2940J-8.0/883 5962-9088301QEA	LM2940J-12/883 5962-9088401QEA	LM2940J-15/883 5962-9088501QEA	J16A
	LM2940WG5.0/883 5962-8958701XA				WG16A

For information on military temperature range products, please go to the Mil/Aero Web Site at <http://www.national.com/appinfo/milaero/index.html>.

Connection Diagrams

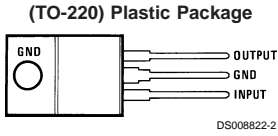

Front View

Order Number LM2940CT-5.0, LM2940CT-9.0,
LM2940CT-12, LM2940CT-15, LM2940T-5.0,
LM2940T-8.0, LM2940T-9.0,
LM2940T-10 or LM2940T-12
See NS Package Number TO3B

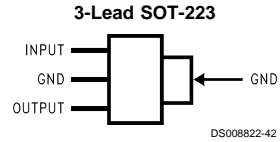

Front View

Order Part Number LM2940IMP-5.0,
LM2940IMP-8.0, LM2940IMP-9.0,
LM2940IMP-10, LM2940IMP-12 or LM2940IMP-15
See NS Package Number MA04A

16-Lead Dual-in-Line Package (J)

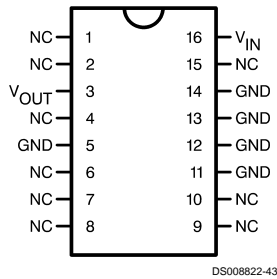

Top View

Order Number LM2940J-5.0/883 (5962-8958701EA),
LM2940J-8.0/883 (5962-9088301QEA),
LM2940J-12/883 (5962-9088401QEA),
LM2940J-15/883 (5962-9088501QEA)
See NS Package Number J16A

16-Lead Ceramic Surface-Mount Package (WG)

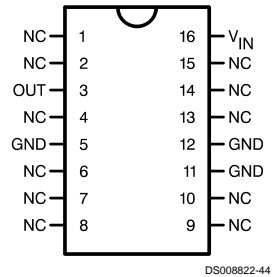

Top View

Order Number LM2940WG5.0/883 (5962-8958701XA)
See NS Package Number WG16A

(TO-263) Surface-Mount Package

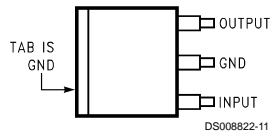

Top View



Side View

Order Number LM2940CS-5.0, LM2940CS-9.0,
LM2940CS-12, LM2940CS-15,
LM2940S-5.0, LM2940S-8.0,
LM2940S-9.0, LM2940S-10 or LM2940S-12
See NS Package Number TS3B

Absolute Maximum Ratings (Note 1)

If Military/Aerospace specified devices are required, please contact the National Semiconductor Sales Office/Distributors for availability and specifications.

LM2940S, T, MP ≤ 100 ms	60V
LM2940CS, T ≤ 1 ms	45V
Internal Power Dissipation	
(Note 2)	Internally Limited
Maximum Junction Temperature	150°C
Storage Temperature Range	-65°C $\leq T_J \leq$ +150°C
Lead Temperature, Time for Wave Soldering	
TO-220 (T) Package	260°C, 10s

TO-263 (S) Package	260°C, 4s
SOT-223 (MP) Package	260°C, 4s
ESD Susceptibility (Note 3)	2 kV

Operating Conditions (Note 1)

Input Voltage	26V
Temperature Range	
LM2940T, LM2940S	-40°C $\leq T_A \leq$ 125°C
LM2940CT, LM2940CS	0°C $\leq T_A \leq$ 125°C
LM2940IMP	-40°C $\leq T_A \leq$ 85°C
LM2940J, LM2940WG	-55°C $\leq T_A \leq$ 125°C

Electrical Characteristics

$V_{IN} = V_O + 5V$, $I_O = 1A$, $C_O = 22 \mu F$, unless otherwise specified. **Boldface limits apply over the entire operating temperature range of the indicated device.** All other specifications apply for $T_A = T_J = 25^\circ C$.

Output Voltage (V_O)		5V			8V			Units
Parameter	Conditions	Typ	LM2940 Limit (Note 4)	LM2940/883 Limit (Note 5)	Typ	LM2940 Limit (Note 4)	LM2940/883 Limit (Note 5)	
Output Voltage	$5 \text{ mA} \leq I_O \leq 1 \text{ A}$	5.00	6.25V $\leq V_{IN} \leq$ 26V		8.00	9.4V $\leq V_{IN} \leq$ 26V		V_{MIN} V_{MAX}
			4.85/ 4.75	4.85/ 4.75		7.76/ 7.60	7.76/ 7.60	
			5.15/ 5.25	5.15/ 5.25		8.24/ 8.40	8.24/ 8.40	
Line Regulation	$V_O + 2V \leq V_{IN} \leq 26V$, $I_O = 5 \text{ mA}$	20	50	40/ 50	20	80	50/ 80	mV_{MAX}
Load Regulation	50 mA $\leq I_O \leq 1 \text{ A}$ LM2940, LM2940/883 LM2940C	35	50/ 80	50/ 100	55	80/ 130	80/ 130	mV_{MAX}
		35	50		55	80		
Output Impedance	100 mADC and 20 mArms, $f_o = 120 \text{ Hz}$	35		1000/ 1000	55		1000/ 1000	$m\Omega$
Quiescent Current	$V_O + 2V \leq V_{IN} \leq 26V$, $I_O = 5 \text{ mA}$ LM2940, LM2940/883 LM2940C	10	15/ 20	15/ 20	10	15/ 20	15/ 20	mA_{MAX}
		10	15		10			
		30	45/ 60	50/ 60	30	45/ 60	50/ 60	mA_{MAX}
	$V_{IN} = V_O + 5V$, $I_O = 1 \text{ A}$							
Output Noise Voltage	10 Hz – 100 kHz, $I_O = 5 \text{ mA}$	150		700/ 700	240		1000/ 1000	μV_{rms}
Ripple Rejection	$f_o = 120 \text{ Hz}$, $1 V_{rms}$, $I_O = 100 \text{ mA}$ LM2940 LM2940C	72	60/ 54		66	54/ 48		dB_{MIN}
		72	60		66	54		
	$f_o = 1 \text{ kHz}$, $1 V_{rms}$, $I_O = 5 \text{ mA}$			60/ 50			54/ 48	dB_{MIN}
Long Term Stability		20			32			$mV/$ 1000 Hr
Dropout Voltage	$I_O = 1 \text{ A}$	0.5	0.8/ 1.0	0.7/ 1.0	0.5	0.8/ 1.0	0.7/ 1.0	V_{MAX}
	$I_O = 100 \text{ mA}$	110	150/ 200	150/ 200	110	150/ 200	150/ 200	mV_{MAX}
Short Circuit Current	(Note 6)	1.9	1.6	1.5/ 1.3	1.9	1.6	1.6/ 1.3	A_{MIN}

Electrical Characteristics (Continued)

$V_{IN} = V_O + 5V$, $I_O = 1A$, $C_O = 22 \mu F$, unless otherwise specified. **Boldface limits apply over the entire operating temperature range of the indicated device.** All other specifications apply for $T_A = T_J = 25^\circ C$.

Output Voltage (V_O)		5V			8V			Units
Parameter	Conditions	Typ	LM2940 Limit (Note 4)	LM2940/883 Limit (Note 5)	Typ	LM2940 Limit (Note 4)	LM2940/883 Limit (Note 5)	
Maximum Line Transient	$R_O = 100\Omega$ LM2940, $T \leq 100$ ms	75	60/ 60		75	60/ 60		V_{MIN}
	LM2940/883, $T \leq 20$ ms LM2940C, $T \leq 1$ ms	55	45	40/ 40	55	45	40/ 40	
Reverse Polarity DC Input Voltage	$R_O = 100\Omega$ LM2940, LM2940/883	-30	-15/- 15	-15/- 15	-30	-15/- 15	-15/- 15	V_{MIN}
	LM2940C	-30	-15		-30	-15		
Reverse Polarity Transient Input Voltage	$R_O = 100\Omega$ LM2940, $T \leq 100$ ms	-75	-50/- 50		-75	-50/- 50		V_{MIN}
	LM2940/883, $T \leq 20$ ms			-45/- 45			-45/- 45	
	LM2940C, $T \leq 1$ ms	-55	-45/- 45					

Electrical Characteristics

$V_{IN} = V_O + 5V$, $I_O = 1A$, $C_O = 22 \mu F$, unless otherwise specified. **Boldface limits apply over the entire operating temperature range of the indicated device.** All other specifications apply for $T_A = T_J = 25^\circ C$.

Output Voltage (V_O)		9V		10V		Units
Parameter	Conditions	Typ	LM2940 Limit (Note 4)	Typ	LM2940 Limit (Note 4)	
Output Voltage	$5 \text{ mA} \leq I_O \leq 1A$	$10.5V \leq V_{IN} \leq 26V$		$11.5V \leq V_{IN} \leq 26V$		V_{MIN} V_{MAX}
		9.00	8.73/ 8.55 9.27/ 9.45	10.00	9.70/ 9.50 10.30/ 10.50	
Line Regulation	$V_O + 2V \leq V_{IN} \leq 26V$, $I_O = 5 \text{ mA}$	20	90	20	100	mV_{MAX}
Load Regulation	$50 \text{ mA} \leq I_O \leq 1A$ LM2940 LM2940C	60	90/ 150	65	100/ 165	mV_{MAX}
		60	90			
Output Impedance	100 mADC and 20 mArms, $f_O = 120 \text{ Hz}$	60		65		$m\Omega$
Quiescent Current	$V_O + 2V \leq V_{IN} < 26V$, $I_O = 5 \text{ mA}$ LM2940 LM2940C	10	15/ 20	10	15/ 20	mA_{MAX}
		10	15			
		$V_{IN} = V_O + 5V$, $I_O = 1A$	30	45/ 60	30	
Output Noise Voltage	10 Hz - 100 kHz, $I_O = 5 \text{ mA}$	270		300		μV_{rms}
Ripple Rejection	$f_O = 120 \text{ Hz}$, $1 V_{rms}$, $I_O = 100 \text{ mA}$ LM2940 LM2940C	64	52/ 46	63	51/ 45	dB_{MIN}
		64	52			
Long Term Stability		34		36		$mV/$ 1000 Hr
Dropout Voltage	$I_O = 1A$	0.5	0.8/ 1.0	0.5	0.8/ 1.0	V_{MAX}
	$I_O = 100 \text{ mA}$	110	150/ 200	110	150/ 200	mV_{MAX}

Electrical Characteristics (Continued)

$V_{IN} = V_O + 5V$, $I_O = 1A$, $C_O = 22 \mu F$, unless otherwise specified. **Boldface limits apply over the entire operating temperature range of the indicated device.** All other specifications apply for $T_A = T_J = 25^\circ C$.

Output Voltage (V_O)		9V		10V		Units
Parameter	Conditions	Typ	LM2940 Limit (Note 4)	Typ	LM2940 Limit (Note 4)	
Short Circuit Current	(Note 6)	1.9	1.6	1.9	1.6	A_{MIN}
Maximum Line Transient	$R_O = 100\Omega$ $T \leq 100 \text{ ms}$					V_{MIN}
	LM2940	75	60/60	75	60/60	
	LM2940C	55	45			
Reverse Polarity DC Input Voltage	$R_O = 100\Omega$					V_{MIN}
	LM2940	-30	-15/-15	-30	-15/-15	
	LM2940C	-30	-15			
Reverse Polarity Transient Input Voltage	$R_O = 100\Omega$ $T \leq 100 \text{ ms}$					V_{MIN}
	LM2940	-75	-50/-50	-75	-50/-50	
	LM2940C	-55	-45/-45			

Electrical Characteristics

$V_{IN} = V_O + 5V$, $I_O = 1A$, $C_O = 22 \mu F$, unless otherwise specified. **Boldface limits apply over the entire operating temperature range of the indicated device.** All other specifications apply for $T_A = T_J = 25^\circ C$.

Output Voltage (V_O)		12V			15V			Units
Parameter	Conditions	Typ	LM2940 Limit (Note 4)	LM2940/833 Limit (Note 5)	Typ	LM2940 Limit (Note 4)	LM2940/833 Limit (Note 5)	
Output Voltage	$5 \text{ mA} \leq I_O \leq 1A$	$13.6V \leq V_{IN} \leq 26V$			$16.75V \leq V_{IN} \leq 26V$			V_{MIN}
		12.00	11.64/11.40	11.64/11.40	15.00	14.55/14.25	14.55/14.25	V_{MAX}
Line Regulation	$V_O + 2V \leq V_{IN} \leq 26V$, $I_O = 5 \text{ mA}$	20	120	75/120	20	150	95/150	mV_{MAX}
Load Regulation	$50 \text{ mA} \leq I_O \leq 1A$	LM2940, LM2940/883	55	120/200			150/240	mV_{MAX}
		LM2940C	55	120	70	150		
Output Impedance	100 mADC and 20 mArms, $f_O = 120 \text{ Hz}$	80		1000/1000	100		1000/1000	$m\Omega$
Quiescent Current	$V_O + 2V \leq V_{IN} \leq 26V$, $I_O = 5 \text{ mA}$	LM2940, LM2940/883	10	15/20			15/20	mA_{MAX}
		LM2940C	10	15	10	15		
	$V_{IN} = V_O + 5V$, $I_O = 1A$	30	45/60	50/60	30	45/60	50/60	mA_{MAX}
Output Noise Voltage	10 Hz – 100 kHz, $I_O = 5 \text{ mA}$	360		1000/1000	450		1000/1000	μV_{rms}
Ripple Rejection	$f_O = 120 \text{ Hz}$, $1 V_{rms}$, $I_O = 100 \text{ mA}$	LM2940	66	54/48				dB_{MIN}
		LM2940C	66	54	64	52		
	$f_O = 1 \text{ kHz}$, $1 V_{rms}$, $I_O = 5 \text{ mA}$			52/46			48/42	dB_{MIN}

Electrical Characteristics (Continued)

$V_{IN} = V_O + 5V$, $I_O = 1A$, $C_O = 22 \mu F$, unless otherwise specified. **Boldface limits apply over the entire operating temperature range of the indicated device.** All other specifications apply for $T_A = T_J = 25^\circ C$.

Output Voltage (V_O)		12V			15V			Units
Parameter	Conditions	Typ	LM2940 Limit (Note 4)	LM2940/833 Limit (Note 5)	Typ	LM2940 Limit (Note 4)	LM2940/833 Limit (Note 5)	
Long Term Stability		48			60			mV/ 1000 Hr
Dropout Voltage	$I_O = 1A$	0.5	0.8/ 1.0	0.7/ 1.0	0.5	0.8/ 1.0	0.7/ 1.0	V_{MAX}
	$I_O = 100 \text{ mA}$	110	150/ 200	150/ 200	110	150/ 200	150/ 200	mV_{MAX}
Short Circuit Current	(Note 6)	1.9	1.6	1.6/ 1.3	1.9	1.6	1.6/ 1.3	A_{MIN}
Maximum Line Transient	$R_O = 100\Omega$							
	LM2940, $T \leq 100 \text{ ms}$	75	60/ 60					V_{MIN}
	LM2940/883, $T \leq 20 \text{ ms}$ LM2940C, $T \leq 1 \text{ ms}$	55	45	40/ 40	55	45	40/ 40	
Reverse Polarity DC Input Voltage	$R_O = 100\Omega$							
	LM2940, LM2940/883 LM2940C	-30	-15/ -15	-15/ -15	-30	-15	-15/ -15	V_{MIN}
Reverse Polarity Transient Input Voltage	$R_O = 100\Omega$							
	LM2940, $T \leq 100 \text{ ms}$	-75	-50/ -50					V_{MIN}
	LM2940/883, $T \leq 20 \text{ ms}$ LM2940C, $T \leq 1 \text{ ms}$	-55	-45/ -45	-45/ -45	-55	-45/ -45	-45/ -45	

Note 1: Absolute Maximum Ratings are limits beyond which damage to the device may occur. Operating Conditions are conditions under which the device functions but the specifications might not be guaranteed. For guaranteed specifications and test conditions see the Electrical Characteristics.

Note 2: The maximum allowable power dissipation is a function of the maximum junction temperature, T_J , the junction-to-ambient thermal resistance, θ_{J-A} , and the ambient temperature, T_A . Exceeding the maximum allowable power dissipation will cause excessive die temperature, and the regulator will go into thermal shutdown. The value of θ_{J-A} (for devices in still air with no heatsink) is $60^\circ C/W$ for the TO-220 package, $80^\circ C/W$ for the TO-263 package, and $174^\circ C/W$ for the SOT-223 package. The effective value of θ_{J-A} can be reduced by using a heatsink (see Application Hints for specific information on heatsinking). The values of θ_{J-A} and θ_{J-C} for the K02A package are $39^\circ C/W$ and $4^\circ C/W$ respectively.

Note 3: ESD rating is based on the human body model, 100 pF discharged through 1.5 k Ω .

Note 4: All limits are guaranteed at $T_A = T_J = 25^\circ C$ only (standard typeface) or over the entire operating temperature range of the indicated device (boldface type). All limits at $T_A = T_J = 25^\circ C$ are 100% production tested. All limits at temperature extremes are guaranteed via correlation using standard Statistical Quality Control methods.

Note 5: All limits are guaranteed at $T_A = T_J = 25^\circ C$ only (standard typeface) or over the entire operating temperature range of the indicated device (boldface type). All limits are 100% production tested and are used to calculate Outgoing Quality Levels.

Note 6: Output current will decrease with increasing temperature but will not drop below 1A at the maximum specified temperature.

Typical Performance Characteristics

Dropout Voltage

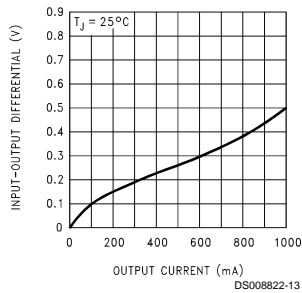

Dropout Voltage vs Temperature

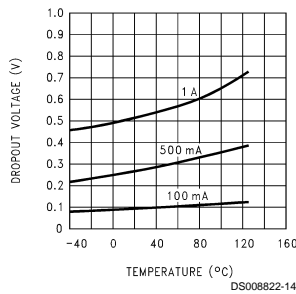

Output Voltage vs Temperature

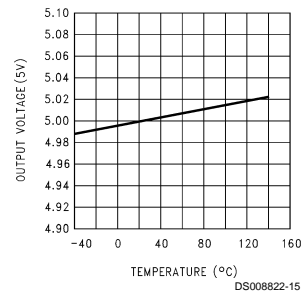

Typical Performance Characteristics (Continued)

Quiescent Current vs Temperature

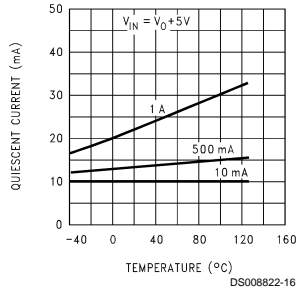

Quiescent Current

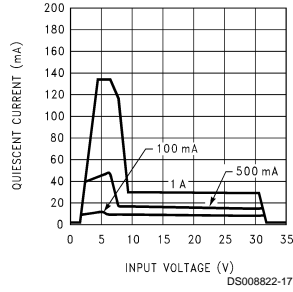

Quiescent Current

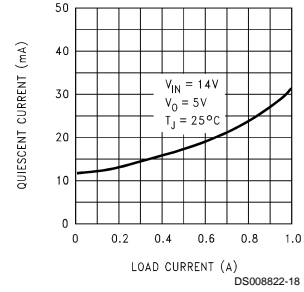

Line Transient Response

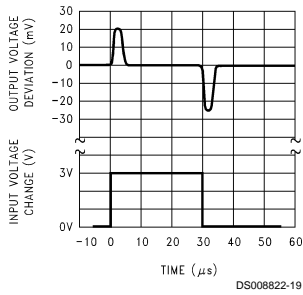

Load Transient Response

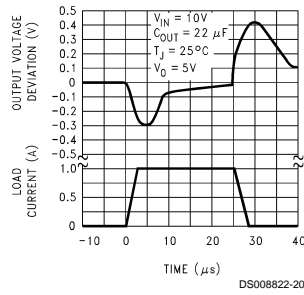

Ripple Rejection

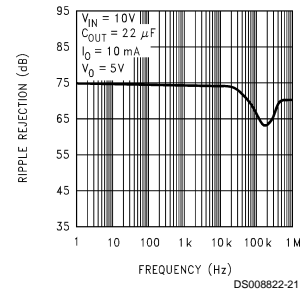

Low Voltage Behavior

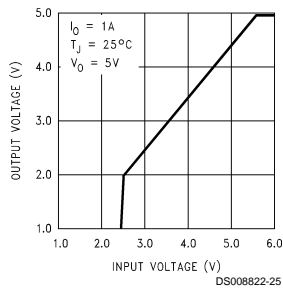

Low Voltage Behavior

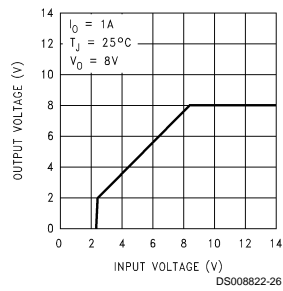

Low Voltage Behavior

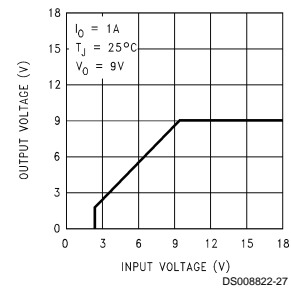

Low Voltage Behavior

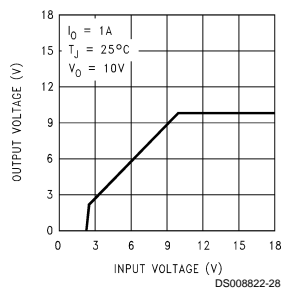

Low Voltage Behavior

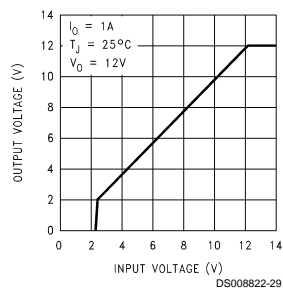

Low Voltage Behavior

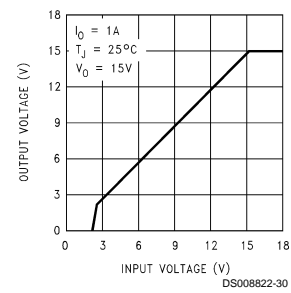

Typical Performance Characteristics (Continued)

Output at Voltage Extremes

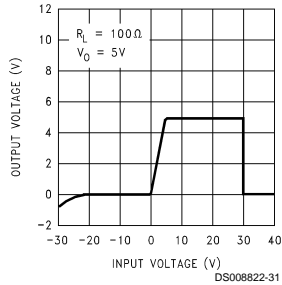

Output at Voltage Extremes

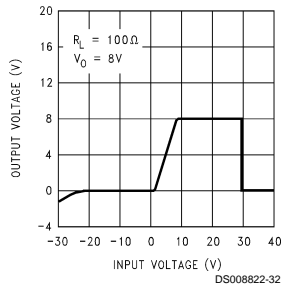

Output at Voltage Extremes

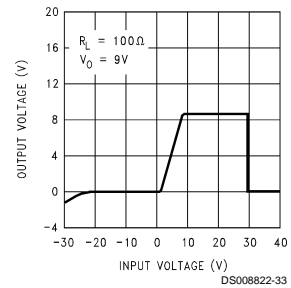

Output at Voltage Extremes

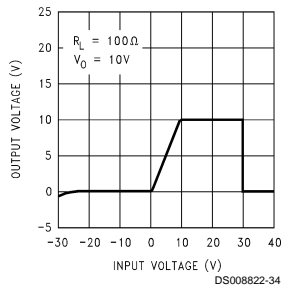

Output at Voltage Extremes

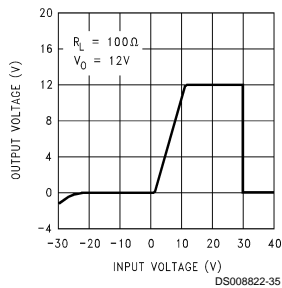

Output at Voltage Extremes

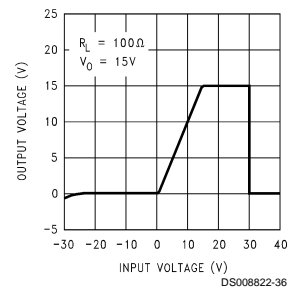

Output Capacitor ESR

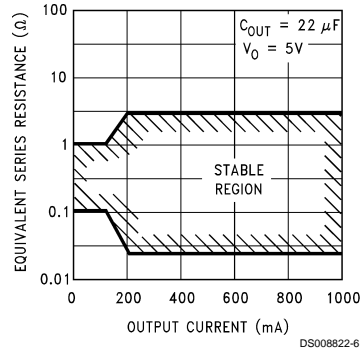

Peak Output Current

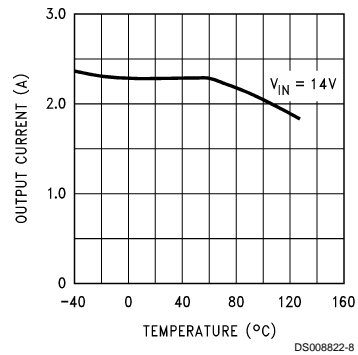

Typical Performance Characteristics (Continued)

Output Impedance

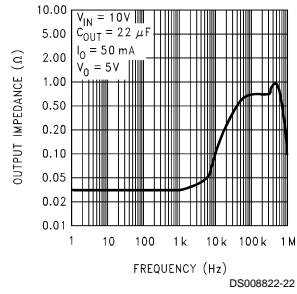

Maximum Power Dissipation (TO-220)

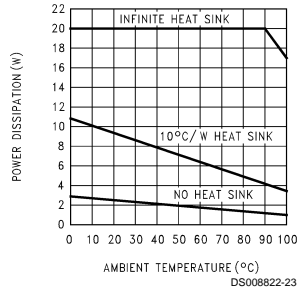

Maximum Power Dissipation (TO-3)

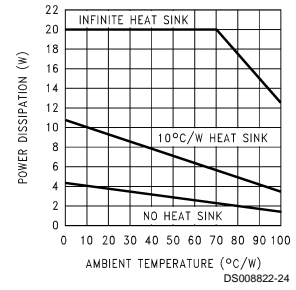

Maximum Power Dissipation (TO-263) See (Note 2)

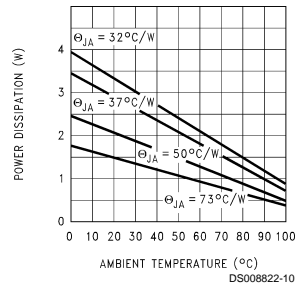

Equivalent Schematic Diagram

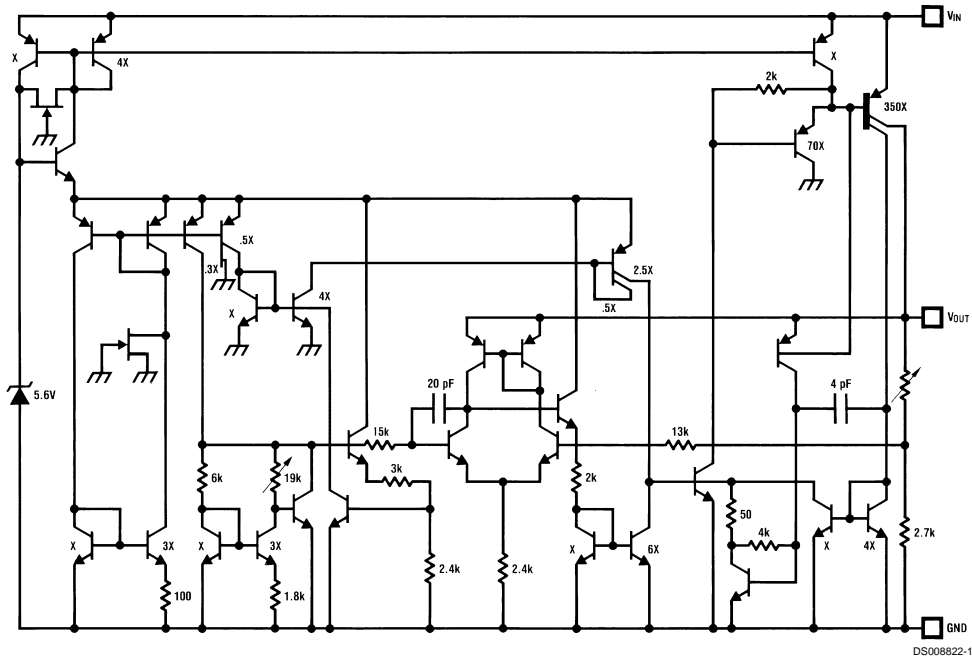

Application Hints

EXTERNAL CAPACITORS

The output capacitor is critical to maintaining regulator stability, and must meet the required conditions for both ESR (Equivalent Series Resistance) and minimum amount of capacitance.

MINIMUM CAPACITANCE:

The minimum output capacitance required to maintain stability is 22 μF (this value may be increased without limit). Larger values of output capacitance will give improved transient response.

ESR LIMITS:

The ESR of the output capacitor will cause loop instability if it is too high or too low. The acceptable range of ESR plotted versus load current is shown in the graph below. **It is essential that the output capacitor meet these requirements, or oscillations can result.**

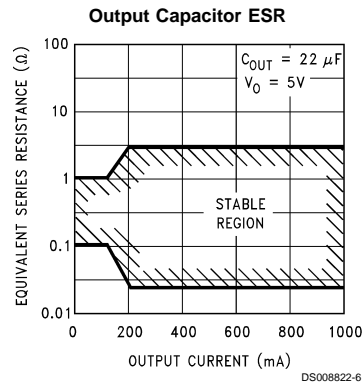

FIGURE 1. ESR Limits

It is important to note that for most capacitors, ESR is specified only at room temperature. However, the designer must ensure that the ESR will stay inside the limits shown over the entire operating temperature range for the design.

For aluminum electrolytic capacitors, ESR will increase by about 30X as the temperature is reduced from 25°C to -40°C. This type of capacitor is not well-suited for low temperature operation.

Solid tantalum capacitors have a more stable ESR over temperature, but are more expensive than aluminum electrolytics. A cost-effective approach sometimes used is to parallel

Application Hints (Continued)

an aluminum electrolytic with a solid Tantalum, with the total capacitance split about 75/25% with the Aluminum being the larger value.

If two capacitors are paralleled, the effective ESR is the parallel of the two individual values. The “flatter” ESR of the Tantalum will keep the effective ESR from rising as quickly at low temperatures.

HEATSINKING

A heatsink may be required depending on the maximum power dissipation and maximum ambient temperature of the application. Under all possible operating conditions, the junction temperature must be within the range specified under Absolute Maximum Ratings.

To determine if a heatsink is required, the power dissipated by the regulator, P_D , must be calculated.

The figure below shows the voltages and currents which are present in the circuit, as well as the formula for calculating the power dissipated in the regulator:

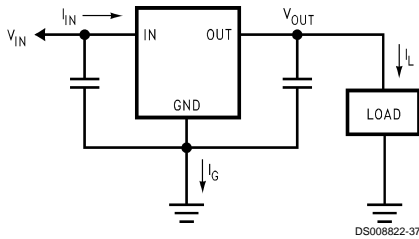

$$I_{IN} = I_L + I_G$$

$$P_D = (V_{IN} - V_{OUT}) I_L + (V_{IN}) I_G$$

FIGURE 2. Power Dissipation Diagram

The next parameter which must be calculated is the maximum allowable temperature rise, T_R (max). This is calculated by using the formula:

$$T_R \text{ (max)} = T_J \text{ (max)} - T_A \text{ (max)}$$

where: T_J (max) is the maximum allowable junction temperature, which is 125°C for commercial grade parts.

T_A (max) is the maximum ambient temperature which will be encountered in the application.

Using the calculated values for T_R (max) and P_D , the maximum allowable value for the junction-to-ambient thermal resistance, $\theta_{(J-A)}$, can now be found:

$$\theta_{(J-A)} = T_R \text{ (max)}/P_D$$

IMPORTANT: If the maximum allowable value for $\theta_{(J-A)}$ is found to be $\geq 53^\circ\text{C/W}$ for the TO-220 package, $\geq 80^\circ\text{C/W}$ for the TO-263 package, or $\geq 174^\circ\text{C/W}$ for the SOT-223 package, no heatsink is needed since the package alone will dissipate enough heat to satisfy these requirements.

If the calculated value for $\theta_{(J-A)}$ falls below these limits, a heatsink is required.

HEATSINKING TO-220 PACKAGE PARTS

The TO-220 can be attached to a typical heatsink, or secured to a copper plane on a PC board. If a copper plane is to be used, the values of $\theta_{(J-A)}$ will be the same as shown in the next section for the TO-263.

If a manufactured heatsink is to be selected, the value of heatsink-to-ambient thermal resistance, $\theta_{(H-A)}$, must first be calculated:

$$\theta_{(H-A)} = \theta_{(J-A)} - \theta_{(C-H)} - \theta_{(J-C)}$$

Where: $\theta_{(J-C)}$ is defined as the thermal resistance from the junction to the surface of the case. A value of 3°C/W can be assumed for $\theta_{(J-C)}$ for this calculation.

$\theta_{(C-H)}$ is defined as the thermal resistance between the case and the surface of the heatsink. The value of $\theta_{(C-H)}$ will vary from about 1.5°C/W to about 2.5°C/W (depending on method of attachment, insulator, etc.). If the exact value is unknown, 2°C/W should be assumed for $\theta_{(C-H)}$.

When a value for $\theta_{(H-A)}$ is found using the equation shown, a heatsink must be selected that has a value that is less than or equal to this number.

$\theta_{(H-A)}$ is specified numerically by the heatsink manufacturer in the catalog, or shown in a curve that plots temperature rise vs power dissipation for the heatsink.

HEATSINKING TO-263 AND SOT-223 PACKAGE PARTS

Both the TO-263 (“S”) and SOT-223 (“MP”) packages use a copper plane on the PCB and the PCB itself as a heatsink. To optimize the heat sinking ability of the plane and PCB, solder the tab of the package to the plane.

Figure 3 shows for the TO-263 the measured values of $\theta_{(J-A)}$ for different copper area sizes using a typical PCB with 1 ounce copper and no solder mask over the copper area used for heatsinking.

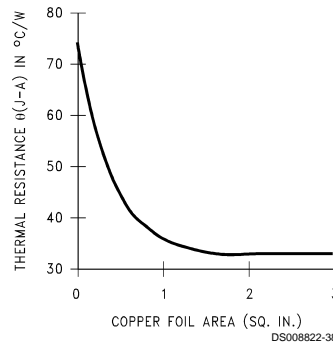

FIGURE 3. $\theta_{(J-A)}$ vs Copper (1 ounce) Area for the TO-263 Package

As shown in the figure, increasing the copper area beyond 1 square inch produces very little improvement. It should also be observed that the minimum value of $\theta_{(J-A)}$ for the TO-263 package mounted to a PCB is 32°C/W.

As a design aid, Figure 4 shows the maximum allowable power dissipation compared to ambient temperature for the TO-263 device (assuming $\theta_{(J-A)}$ is 35°C/W and the maximum junction temperature is 125°C).

Application Hints (Continued)

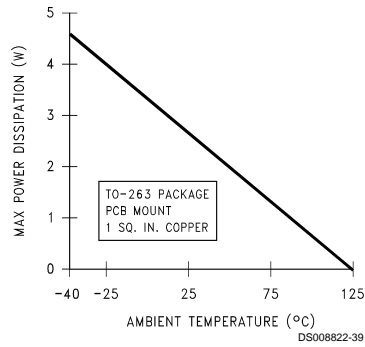

FIGURE 4. Maximum Power Dissipation vs T_{AMB} for the TO-263 Package

Figure 5 and Figure 6 show the information for the SOT-223 package. Figure 6 assumes a $\theta_{(J-A)}$ of 74°C/W for 1 ounce copper and 51°C/W for 2 ounce copper and a maximum junction temperature of 125°C.

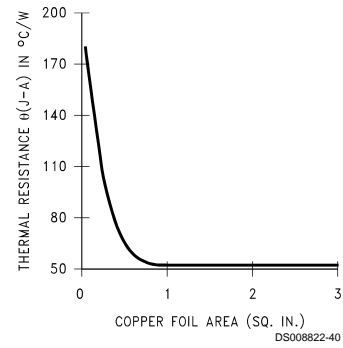

FIGURE 5. $\theta_{(J-A)}$ vs Copper (2 ounce) Area for the SOT-223 Package

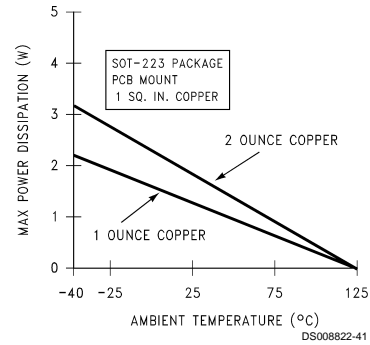
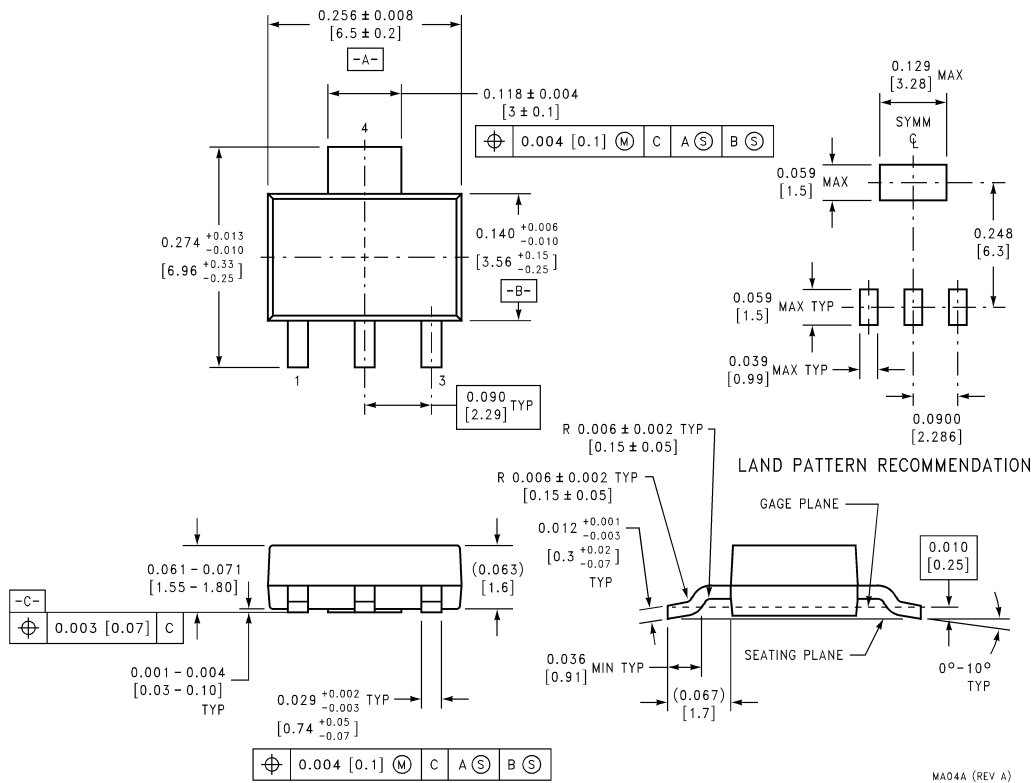

FIGURE 6. Maximum Power Dissipation vs T_{AMB} for the SOT-223 Package

Physical Dimensions inches (millimeters) unless otherwise noted



3-Lead SOT-223 Package
Order Part Number LM2940IMP-5.0
LM2940IMP-8.0 LM2940IMP-9.0
LM2940IMP-10 LM2940IMP-12 LM2940IMP-15
NS Package Number MA04A

MA04A (REV A)

Physical Dimensions inches (millimeters) unless otherwise noted (Continued)

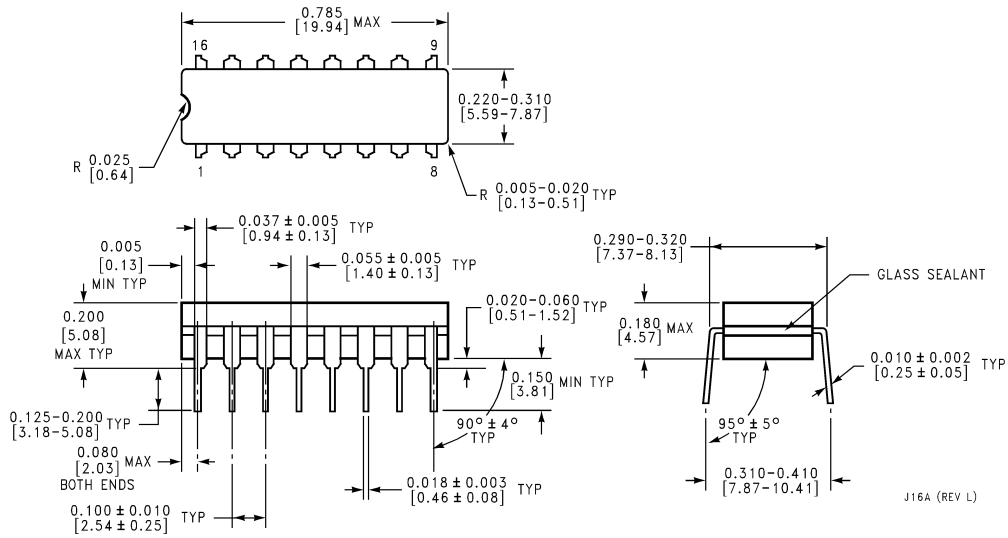

16 Lead Dual-in-Line Package (J)
Order Number LM2940J-5.0/883 (5962-8958701EA),
LM2940J-8.0/883 (5962-9088301QEA),
LM2940J-12/883 (5962-9088401QEA),
LM2940J-15/883 (5962-9088501QEA)
See NS Package Number J16A

Physical Dimensions inches (millimeters) unless otherwise noted (Continued)

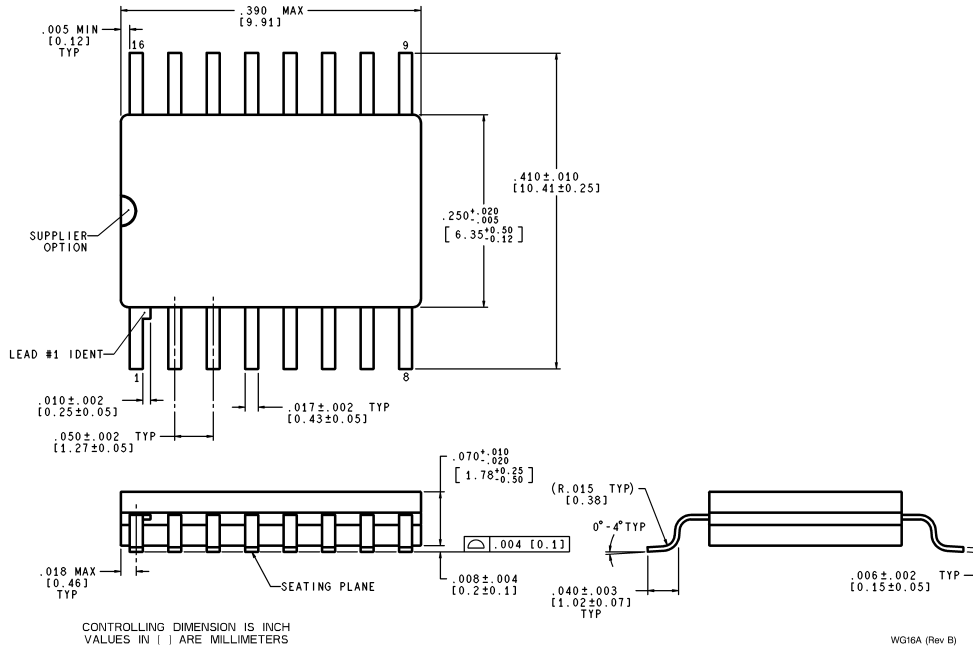

16 Lead Surface Mount Package (WG)
Order Number LM2940WG5.0/883 (5962-8958701XA)
See NS Package Number WG16A

Physical Dimensions inches (millimeters) unless otherwise noted (Continued)

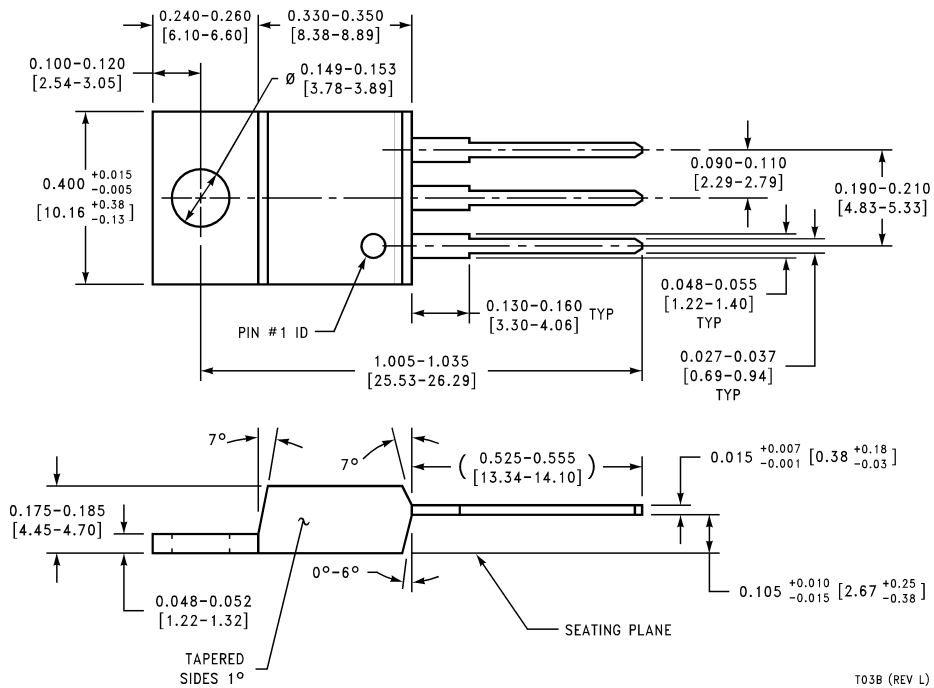

TO3B (REV L)

3-Lead TO-220 Plastic Package (T)
Order Number LM2940T-5.0, LM2940T-8.0,
LM2940T-9.0, LM2940T-10, LM2940T-12, LM2940CT-5.0,
LM2940CT-12 or LM2940CT-15
NS Package Number TO3B

Physical Dimensions inches (millimeters) unless otherwise noted (Continued)

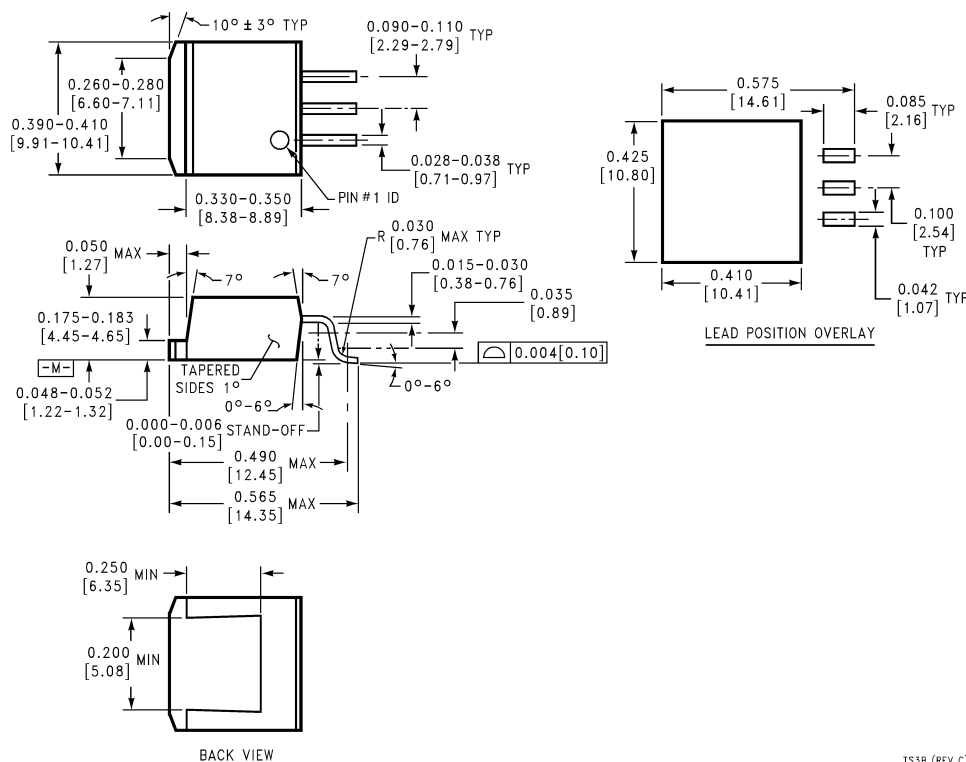

3-Lead TO-263 Surface Mount Package (MP)
Order Number LM2940S-5.0, LM2940S-8.0,
LM2940S-9.0, LM2940S-10, LM2940S-12,
LM2940CS-5.0, LM2940CS-12 or LM2940CS-15
NS Package Number TS3B

TS3B (REV C)

LIFE SUPPORT POLICY

NATIONAL'S PRODUCTS ARE NOT AUTHORIZED FOR USE AS CRITICAL COMPONENTS IN LIFE SUPPORT DEVICES OR SYSTEMS WITHOUT THE EXPRESS WRITTEN APPROVAL OF THE PRESIDENT AND GENERAL COUNSEL OF NATIONAL SEMICONDUCTOR CORPORATION. As used herein:

1. Life support devices or systems are devices or systems which, (a) are intended for surgical implant into the body, or (b) support or sustain life, and whose failure to perform when properly used in accordance with instructions for use provided in the labeling, can be reasonably expected to result in a significant injury to the user.
2. A critical component is any component of a life support device or system whose failure to perform can be reasonably expected to cause the failure of the life support device or system, or to affect its safety or effectiveness.

National Semiconductor Corporation
 Americas
 Tel: 1-800-272-9959
 Fax: 1-800-737-7018
 Email: support@nsc.com

National Semiconductor Europe
 Fax: +49 (0) 1 80-530 85 86
 Email: europe.support@nsc.com
 Deutsch Tel: +49 (0) 1 80-530 85 85
 English Tel: +49 (0) 1 80-532 78 32
 Français Tel: +49 (0) 1 80-532 93 58
 Italiano Tel: +49 (0) 1 80-534 16 80

National Semiconductor Asia Pacific Customer Response Group
 Tel: 65-2544466
 Fax: 65-2504466
 Email: sea.support@nsc.com

National Semiconductor Japan Ltd.
 Tel: 81-3-5639-7560
 Fax: 81-3-5639-7507

www.national.com