

# Digital Communications, Advanced Course

- Very fast development of high performing digital communication systems.
- The last 20 years has shown an impressive development, and the next 20 years will be even more dramatic!
- Modern communication systems requires state-of-the-art software and hardware technology and they are among the most advanced technical systems that we have today.

# Communication trends

- **Different users and applications require different bit rates and error protection (imply adaptive systems).**
- **Mobile broadband, machine-type-communications, Internet-of-things, tactile Internet, device-to-device communications,.....**
- **To increase the performance the communication system should be able to adapt to the current quality of the communication link.  
The system should always work close to maximum performance!**
- **MIMO and OFDM are examples of advanced methods.**
- **LTE and Digital TV are examples of advanced systems.**
- **The demand for higher and higher bitrates drives the development of more advanced and sophisticated communication system solutions.**

- **In this course we will study modern advanced digital communication methods and systems.**
- **Stationary as well as mobile communication system solutions.**
- **This course gives a breadth and a depth so that you can understand today's advanced communication system, and also many future systems.**

# Project work in this course

- 2 students/group.
- A communication application/technical problem/problem area, relevant for the course, is investigated.
- The choice of project is mainly done by the project group.
- Articles and conference papers from IEEE's database "IEEE Xplore"

<http://ieeexplore.ieee.org/Xplore/DynWel.jsp>

is recommended to get additional technical information.

- Written report, oral presentation, and be opponent to another group.

# Some examples of applications/systems studied in previous projects:

- Mobile telephony/broadband (GSM, EDGE, LTE, 4G, 5G,...)
- Internet
- Modem (e.g., ADSL)
- WLAN (Wireless Local Area Network)
- Digital TV
- MIMO
- Massive MIMO
- OFDM+MIMO
- GPS (Global Positioning System)
- Bluetooth
- mmWave

## A communication link:

- **Different requirements on error protection.**
- **Different requirement on bit rate (bps) and bandwidth (Hz).**
- **Different qualities of the communication link.**
  
- **What are the technical challenges/problems and limitations?**
- **How do we solve these?**

# Course Programme

**Digital Communications, Advanced Course (ETTN01), 7.5 hp, 171030 – 180110**

**First lecture:** Monday 30 October (week 44), 15.15 – 17.00 in E:2311.

**Project starts in week 44.**

**Laboratory lesson:** LAB (4 hours) starts on Tuesday 5 December 2017 (week 49 = Study week 6).

**Application** to the laboratory lesson is made on the homepage of this course where you book one available time-slot. Applications can be made one week before the lab starts, or maybe earlier, check Messages!

**Messages** will be distributed on the homepage of this course, <http://www.eit.lth.se/kurs/ettn01> . Check messages at least twice a week!

**Written Examination:**

1:st opportunity: Wednesday 10 January 2018, 14.00 – 19.00, Sparta D

2:nd opportunity: Monday 9 April 2018, 08.00 – 13.00, E:2311

3:rd opportunity: Not yet scheduled. Likely in August 2018

- Course Literature:**
- “Introduction to Digital Communications”, compendium August 2006.
  - Lecture notes on OFDM
  - Manual for the laboratory lesson.

The lecture notes on OFDM, and the manual for the laboratory lesson will be available on the homepage of this course, (they are not available yet).

*You are allowed to use the compendium and the lecture notes on OFDM during the written examination.*

*This course is defined by the pages and problems given in the course outline given below in this course program, and by the laboratory lesson.*



**Lecturer:** Fredrik Rusek, Room E:2377, mail: [Fredrik.Rusek@eit.lth.se](mailto:Fredrik.Rusek@eit.lth.se)

**Teaching assistant:** Muhammad Umar Farooq, Room E:2367, mail: [muhammad.umar\\_farooq@eit.lth.se](mailto:muhammad.umar_farooq@eit.lth.se)

**Lectures:** Mondays 15.15 – 17.00 in E:2311

Wednesdays 15.15 – 17.00 in E:2517

**Exercise class :** Tuesdays 13.15 – 15.00 in E:2517

Thursdays 10.15 – 12.00 in E:2517

**Time plan for the project and lab:**

Study week 1: Study period starts. Try to find a project partner as soon as possible. **Send me an email this week containing names and email to the two persons in the project group!**

Study week 2: Lecture Monday 6 November: **Project info & start-up procedure.**

Study weeks 3+4+5: **Project work.**

Study week 4: Send me an email and describe in short the status of your project work.

Study week 5: **Deadline for the project report** (pdf-format, Email) Thursday 30 November 2017, 17.00.

Study week 6: LAB starts.

Study weeks 6+7: **Project presentations and opponents.**

Study week 7: Last study week with planned course activities.

<u>Week</u>	<u>Contents</u>
44	<u>Lecture (30/10)</u> : Introduction. 5.1 – 5.1.2 (pages 329-341). <u>Exercise (31/10)</u> : Problems 5.1, 5.11, Example 5.2 on page 334, 5.6i, 5.9. <u>Lecture (1/11)</u> : 5.1.2 – 5.1.7 (pages 336 – 360). <u>Exercise (2/11)</u> : 5.15a, 5.19, 5.16b, Example 5.4 on page 343, 5.13a, 5.14.
45	<u>Lecture (6/11)</u> : Project info and start-up procedure , 5.2 (pages 360 – 377). <u>Exercise (7/11)</u> : 5.20, 5.18a, 5.21, 5.23, Example 5.20 on page 373, 5.30. <u>Lecture (8/11)</u> : 5.4.1 (pages 380 – 392), Example 5.34, Figure 5.26 on page 393, 5.4.4 – 5.4.6 (pages 396 – 405). <u>Exercise (9/11)</u> : Example 5.23 on page 384, 4.34i), 5.34, 5.33.
46	<u>Lecture (13/11)</u> : 3.4.1 (pages 161 – 163), Problem 5.34, 3.4.3 (pages 167-170). <u>Exercise (14/11)</u> : 3.16, Example 5.4 on page 343. 5.34 ((5.133) – (5.138)). <u>Lecture (15/11)</u> : 8.1 – 8.2.1(pages 501– 512). OFDM introduction. <u>Exercise (16/11)</u> : 8.1, 8.4, 8.6a,b,c,e, 8.7a,b,c,e, 2.32a,b, 8.8a, Example 8.4 on page 512.
47	<u>Lecture (20/11)</u> : OFDM lecture notes pages 1-45. <u>Exercise (21/11)</u> : OFDM problems X1, X2, X3, X4, X5. <u>Lecture (22/11)</u> : 9.1 – 9.2 (pages 581 – 596). <u>Exercise (23/11)</u> : ): OFDM problems X6, X7, X8, X9, X10, X11
48	<b>Deadline for project report this week on <u>Thursday 30 November, 17.00!</u></b> <u>Lecture (27/11)</u> : 9.2 (591 – 596), Problem 5.34, 7.3(pages 480 – 486). <u>Exercise (28/11)</u> : 9.2, 9.3, 9.4, 9.5. <u>Lecture (29/11)</u> : 7.3.21-7.3.2 (pages 484 - 490). <u>Exercise (30/11)</u> : 9.6, 9.7, 9.8, 9.10
49	<b>Lab starts this week!</b> <u>Lecture (4/12)</u> : Summary of the course. Possibly moved due to travel. More info later at webpage <u>Exercise (5/12)</u> : 7.7, 7.9, 7.10a. <u>Lecture (6/12)</u> : Project presentations Possibly moved due to travel. More info later at webpage <u>Exercise (7/12)</u> : Problem solving/Question time
50	<u>Lecture (11/12)</u> : Project presentations <u>Exercise (12/12)</u> : Problem solving/Question time <u>Lecture (13/12)</u> : Project presentations <u>Exercise (14/12)</u> : Problem solving/Question time Friday 15 December 2017: Study week 7 ends.
2	Written examination Wednesday 10 January 2017, 14.00 – 19.00, Sparta D.

**To be able to understand more advanced communication system solutions, e.g., systems where coding is used and/or mobile systems, we need to get more knowledge about uncoded systems!**

# Chapter 5

## Receivers in Digital Communication Systems - Part II

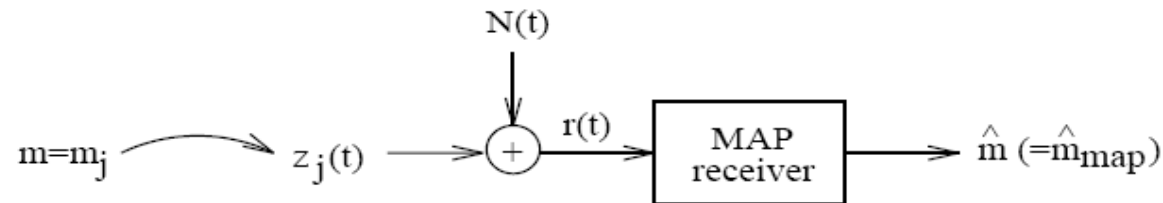

Figure 5.1: Reception of one of  $M$  possible waveforms  $\{z_\ell(t)\}_{\ell=0}^{M-1}$  in AWGN.

The MAP receiver minimizes the symbol error probability!

# Example of a geometrical description of M-ary QAM: (QAM – OFDM – MIMO)

## “From signal waveforms to signal points”

- The **signal space** concept is **general** and powerful.
- Increased insight and understanding.
- Improved analysis and implementations.
- We can understand more complicated systems.

$$\boxed{s_\ell(t) = A_\ell g(t) \cos(2\pi f_c t) - B_\ell g(t) \sin(2\pi f_c t)} \quad \ell = 0, 1, \dots, M - 1 \quad (2.87)$$

$$s_\ell(t) = \underbrace{A_\ell \sqrt{E_g/2}}_{s_{\ell,1}} \phi_1(t) + \underbrace{B_\ell \sqrt{E_g/2}}_{s_{\ell,2}} \phi_2(t) \quad (2.99)$$

$$\phi_1(t) = \frac{g(t) \cos(2\pi f_c t)}{\sqrt{E_g/2}} \quad (2.100)$$

$$\phi_2(t) = -\frac{g(t) \sin(2\pi f_c t)}{\sqrt{E_g/2}} \quad (2.101)$$

$$z_j(t) = \sum_{\ell=1}^N z_{j,\ell} \phi_{\ell}(t) = z_{j,1} \phi_1(t) + z_{j,2} \phi_2(t) + \dots + z_{j,N} \phi_N(t)$$

(5.1)

$$\int_0^{T_s} \phi_i(t) \phi_j(t) dt = \begin{cases} 1 & , \quad i = j \\ 0 & , \quad i \neq j \end{cases} \quad i, j = 1, 2, \dots, N \quad (5.2)$$

$$z_j(t) \iff \mathbf{z}_j = (z_{j,1}, z_{j,2}, \dots, z_{j,N})^{tr}, \quad j = 0, 1, \dots, M-1 \quad (5.3)$$

$$s_{\ell}(t) = A_{\ell} g(t) = A_{\ell} \sqrt{E_g} \cdot \underbrace{\frac{g(t)}{\sqrt{E_g}}}_{\phi_1(t)} = \underbrace{A_{\ell} \sqrt{E_g}}_{s_{\ell,1}} \cdot \phi_1(t) = s_{\ell,1} \cdot \phi_1(t) \quad (2.51)$$

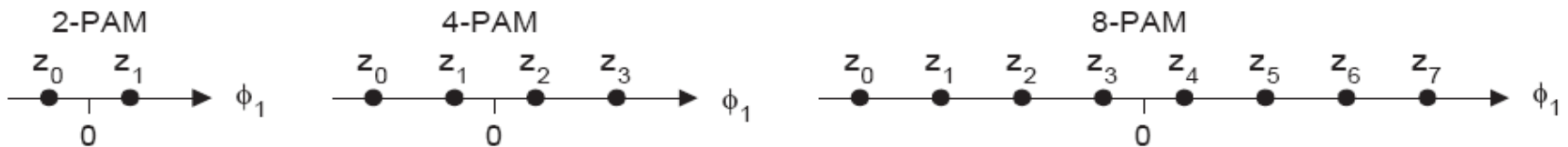

As examples, let us collect some results from subsection 2.4:

$$\begin{aligned}
 \text{M-ary PAM:} \quad & z_j = ((-M + 1 + 2j)\sqrt{E_g}), & N = 1 \\
 \text{M-ary PSK:} \quad & z_j = \left( \cos(\nu_j)\sqrt{\frac{E_g}{2}}, \sin(\nu_j)\sqrt{\frac{E_g}{2}} \right)^{tr}, & N = 2 \\
 \text{M-ary FSK:} \quad & z_j = (0, 0, \dots, \sqrt{E_j}, 0, 0, 0)^{tr}, & N = M \\
 \text{M-ary QAM:} \quad & z_j = \left( A_j\sqrt{\frac{E_g}{2}}, B_j\sqrt{\frac{E_g}{2}} \right)^{tr}, & N = 2
 \end{aligned} \tag{5.4}$$

4-QAM

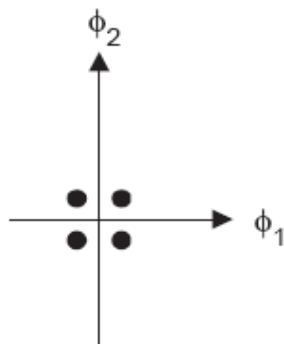

16-QAM

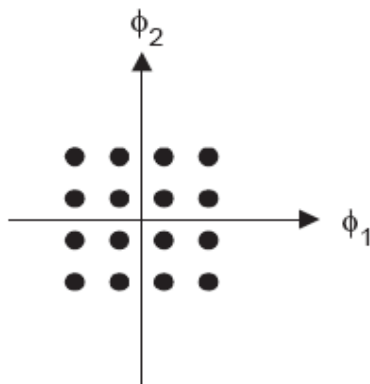

64-QAM

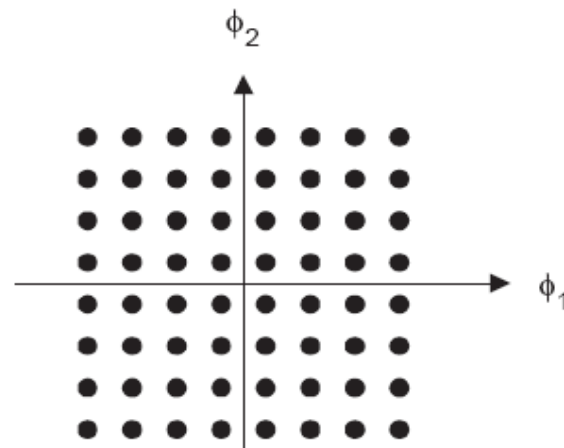

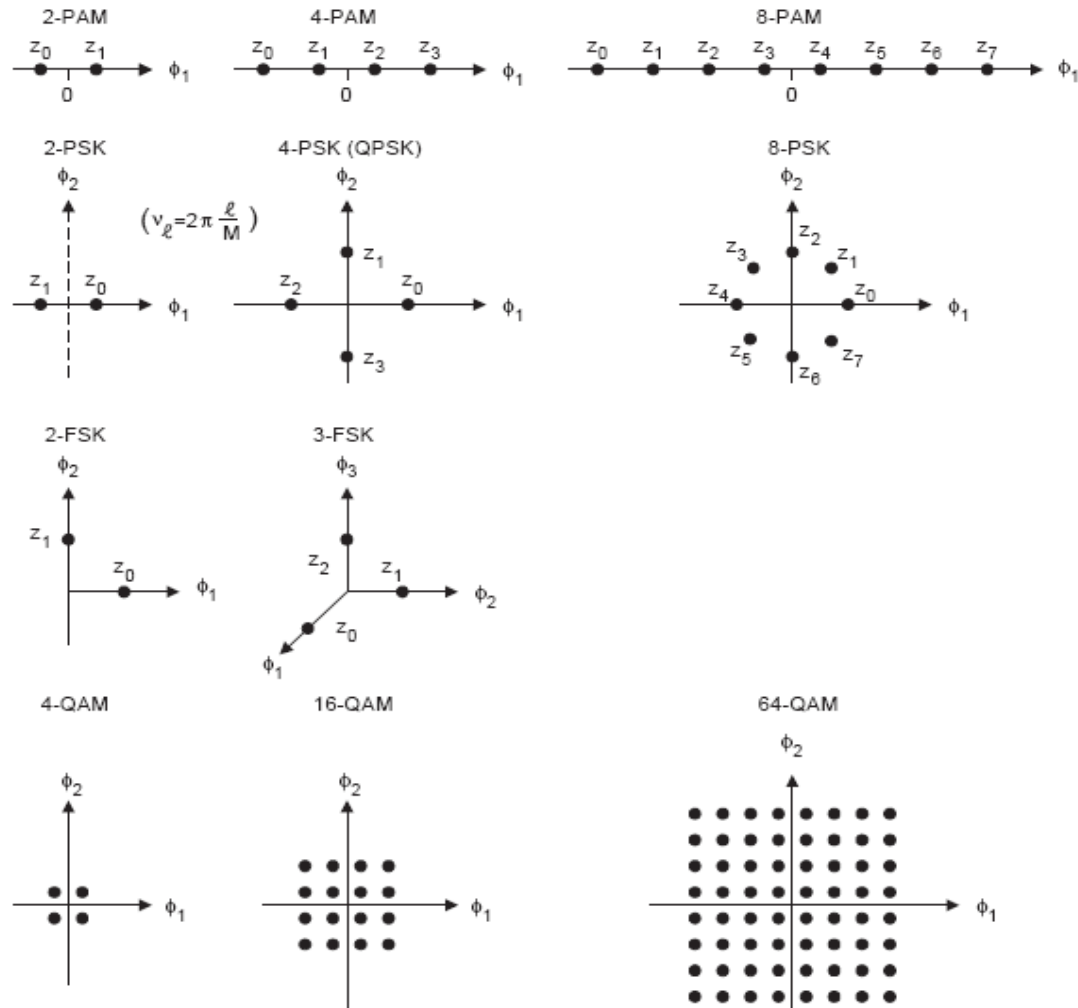

Figure 5.2: Examples of M-ary PAM, M-ary PSK, M-ary FSK and M-ary QAM signal constellations in signal space. See also the corresponding subsections in Chapter 2.



$$\begin{aligned}
 E_j &= \int_0^{T_s} z_j^2(t) dt = \sum_{\ell=1}^N z_{j,\ell}^2 = z_j^{tr} z_j \\
 D_{i,j}^2 &= \int_0^{T_s} (z_i(t) - z_j(t))^2 dt = \sum_{\ell=1}^N (z_{i,\ell} - z_{j,\ell})^2 = \quad , \quad i,j=0,1,\dots,M-1 \\
 &= E_i + E_j - 2z_i^{tr} z_j
 \end{aligned}$$

(5.8)

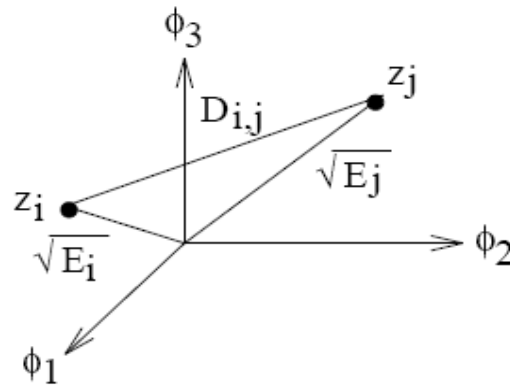
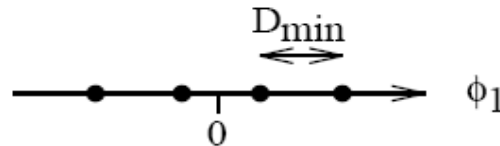

Figure 5.3: Illustrating  $E_\ell$  and  $D_{i,j}$  in signal space.

### EXAMPLE 5.1

The signal space description of 4-ary PAM is given below.



Assume equally likely signal alternatives. Calculate  $d_{\min}^2$ ,  $d_{\min}^2 = D_{\min}^2/2\mathcal{E}_b$ , where  $\mathcal{E}_b$  is (as usual) the average received energy per information bit.

*Solution:*

From the figure we have,  $E_0 = (-3D_{\min}/2)^2$ ,  $E_1 = (-D_{\min}/2)^2$ ,  $E_2 = E_1$ ,  $E_3 = E_0$ .

$$\mathcal{E}_b = \frac{1}{k} \sum_{i=1}^4 P_i E_i = \frac{1}{2} \cdot \frac{1}{4} \left( 2 \cdot \left( \frac{D_{\min}}{2} \right)^2 + 2 \cdot \left( \frac{3D_{\min}}{2} \right)^2 \right) = \frac{5}{8} D_{\min}^2$$

So,

$$d_{\min}^2 = \frac{D_{\min}^2}{2\mathcal{E}_b} = \frac{4}{5}$$

which corresponds to a 3.98 [dB] loss in energy efficiency compared to binary antipodal signaling (or QPSK) for which  $d_{\min}^2 = 2$ .  $\square$

The receiver "looks" in the different dimensions because it is there the information is located!

"look" = scalar product calculation = correlation

$$\int_0^{T_s} z_j(t) \phi_\ell(t) dt = \int_0^{T_s} \sum_{n=1}^N z_{j,n} \phi_n(t) \phi_\ell(t) dt = \sum_{n=1}^N z_{j,n} \int_0^{T_s} \phi_n(t) \phi_\ell(t) dt = z_{j,\ell} \quad (5.12)$$

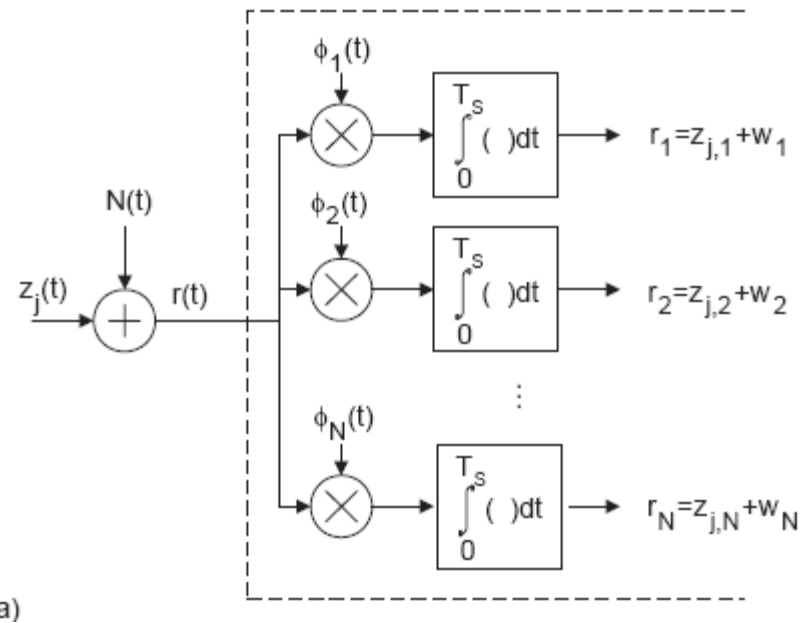

a) Figure 5.6: a) The first step in the MAP receiver;

$$\int_0^{T_s} z_j(t) \phi_\ell(t) dt = \int_0^{T_s} \sum_{n=1}^N z_{j,n} \phi_n(t) \phi_\ell(t) dt = \sum_{n=1}^N z_{j,n} \int_0^{T_s} \phi_n(t) \phi_\ell(t) dt = z_{j,\ell} \quad (5.12)$$

After the correlators we obtain a **received noisy signalpoint**  $r$ !

$$\boxed{\begin{aligned} E\{w_\ell\} &= 0 \\ \sigma_\ell^2 &= E\{w_\ell^2\} = N_0/2 \\ E\{w_\ell w_m\} &= 0, \quad \ell \neq m \end{aligned}} \quad \ell = 1, 2, \dots, N \quad (5.22)$$

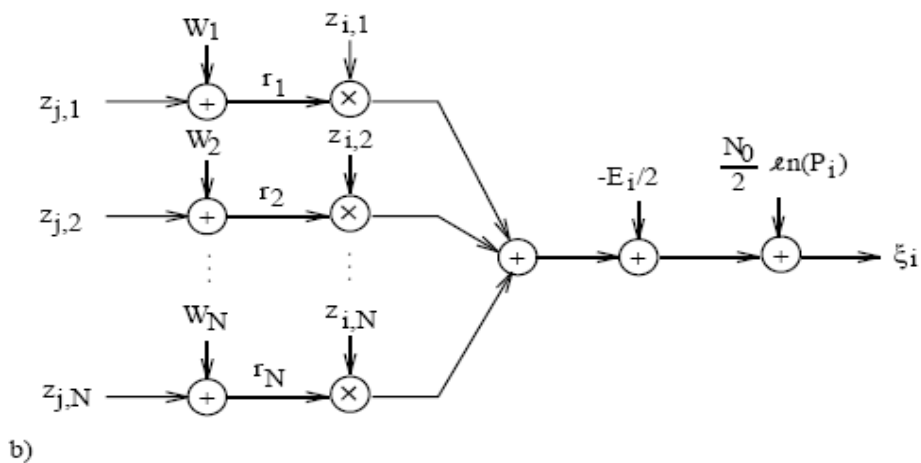
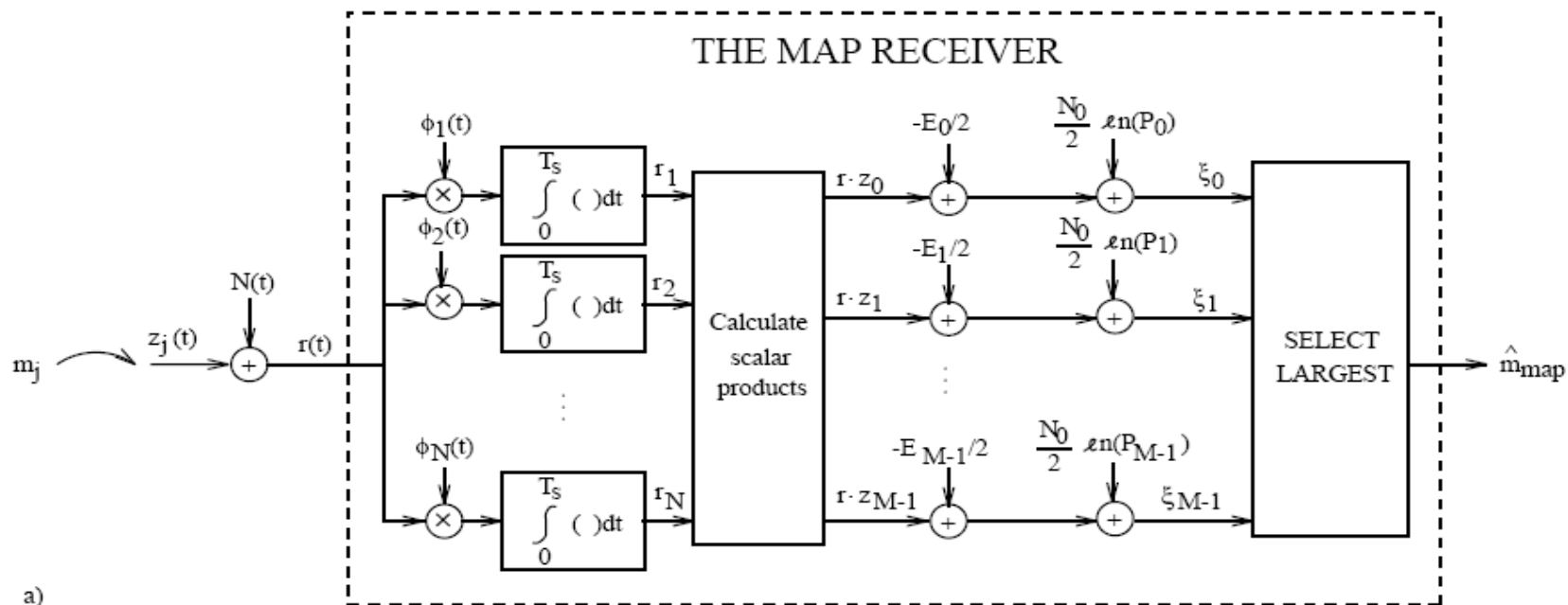

Figure 5.8: a) The MAP receiver; b) A discrete-time model of the decision variable  $\xi_i$ .

$$\boxed{\mathbf{r} = \mathbf{z}_j + \mathbf{w}} \quad (5.18)$$

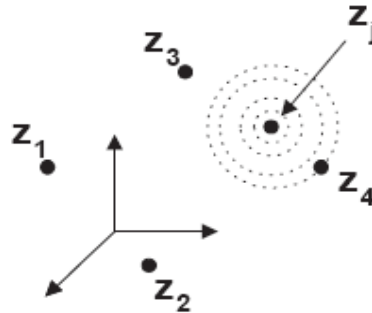

Figure 5.7: Illustrating “the cloud” of noise in  $\mathbf{r}$  if message  $m_j$  is sent.

The distance between the received noisy signal point  $\mathbf{r}$  and the signal point  $\mathbf{z}_j$  is:

$$\boxed{D_{r,j}^2 = (\mathbf{r} - \mathbf{z}_j)^{tr} (\mathbf{r} - \mathbf{z}_j) = \sum_{\ell=1}^N (r_\ell - z_{j,\ell})^2} \quad (5.24)$$

The general MAP decision rule in (4.14) can now be formulated as,

$$\hat{m}(\mathbf{r}) = m_\ell \Leftrightarrow \max_{\{i\}} P_i f_{\mathbf{r}|m_i}(\mathbf{r}|m_i) = P_\ell f_{\mathbf{r}|m_\ell}(\mathbf{r}|m_\ell) \quad (4.18)$$

$$\begin{aligned} f_{\mathbf{r}|m_j}(\mathbf{r}|m_j) &= \\ &= \frac{e^{-(r_1 - z_{j,1})^2/2\sigma^2}}{\sqrt{2\pi} \sigma} \cdot \frac{e^{-(r_2 - z_{j,2})^2/2\sigma^2}}{\sqrt{2\pi} \sigma} \cdots \frac{e^{-(r_N - z_{j,N})^2/2\sigma^2}}{\sqrt{2\pi} \sigma} = \\ &= \frac{e^{-D_{r,j}^2/2\sigma^2}}{(2\pi\sigma^2)^{N/2}}, \quad j = 0, 1, \dots, M - 1 \end{aligned} \quad (5.23)$$

where  $D_{r,j}$  denotes the Euclidean distance in signal space between the received noisy vector  $\mathbf{r}$  and the message point  $\mathbf{z}_j$ ,

MAP decision rule:

$$\hat{m}(\mathbf{r}) = m_\ell \Leftrightarrow \min_{\{i\}} \{D_{r,i}^2 - N_0 \ln(P_i)\} = D_{r,\ell}^2 - N_0 \ln(P_\ell) \quad (5.25)$$

$$\Downarrow$$

$$\max_{\{i\}} \{\mathbf{r}^{tr} \mathbf{z}_i + c_i\} = \mathbf{r}^{tr} \mathbf{z}_\ell + c_\ell$$

ML decision rule = minimum distance decision rule:

In the MAP decision rule (5.25)–(5.26) we observe that if  $P_i = 1/M$ , then the terms  $N_0 \ln(P_\ell)$  can be ignored, resulting in the decision rule

$$\hat{m}(r) = m_\ell \Leftrightarrow \min_{\{i\}} D_{r,i}^2 = D_{r,\ell}^2 \quad (5.28)$$

Hence, *if  $P_i = 1/M$ , then the ML decision rule is obtained as the minimum Euclidean distance decision rule.* Observe also in (5.25) that



### EXAMPLE 5.3

Assume that eight equally likely signal alternatives  $\{z_\ell(t)\}_{\ell=0}^7$  are used, and that  $N = 2$ . The possible noiseless values of the received vector  $\mathbf{r} = (r_1, r_2)^{tr}$  in Figure 5.8a are shown below.

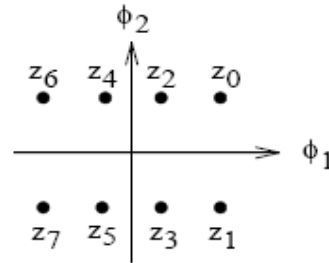

Construct the decision regions used by the MAP-receiver.

#### Solution:

Since the MAP-receiver in this case is identical with the ML receiver, only the Euclidean distances  $D_{r,0}, D_{r,1}, \dots, D_{r,7}$  are used in the decision process. The decision boundaries are therefore drawn exactly in the middle between the different signal points (the ML receiver chooses the signal alternative (message) that is closest to the received noisy signal point  $\mathbf{r}$ ). The result is,

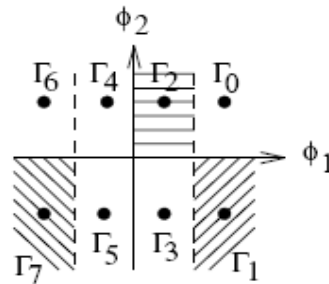

□

### 5.1.3 The Symbol Error Probability for M-ary PAM

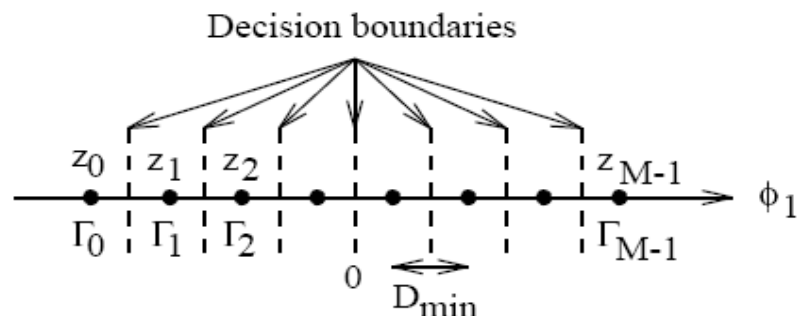

Figure 5.9: The signal space for M-ary PAM with equispaced amplitudes, centered symmetrically around zero (see (5.4)).

$$\begin{aligned}
 \text{Prob}\{\text{error}|m_0 \text{ sent}\} &= \text{Prob}\left\{w_1 > \frac{D_{\min}}{2}\right\} = \\
 &= \text{Prob}\left\{\frac{w_1}{\sqrt{N_0/2}} > \frac{D_{\min}}{\sqrt{2N_0}}\right\} = Q\left(\sqrt{\frac{D_{\min}^2}{2N_0}}\right) \quad (5.31)
 \end{aligned}$$

$$\begin{aligned}
\text{Prob}\{\text{error}|m_1 \text{ sent}\} &= \text{Prob}\left\{w_1 < -\frac{D_{\min}}{2} \text{ or } w_1 > \frac{D_{\min}}{2}\right\} = \\
&= \text{Prob}\left\{\frac{w_1}{\sqrt{N_0/2}} < -\frac{D_{\min}}{\sqrt{2N_0}}\right\} + \text{Prob}\left\{\frac{w_1}{\sqrt{N_0/2}} > \frac{D_{\min}}{\sqrt{2N_0}}\right\} = \\
&= 2Q\left(\sqrt{\frac{D_{\min}^2}{2N_0}}\right)
\end{aligned} \tag{5.32}$$

$$P_s = \sum_{j=0}^{M-1} P_j \text{Prob}\{\text{error}|m_j \text{ sent}\}$$

$$\boxed{P_s = \frac{2}{M} (M-1)Q\left(\sqrt{\frac{D_{\min}^2}{2N_0}}\right)}, \quad \text{M-ary PAM} \tag{5.35}$$

$P_s$  is shown in Figure 5.13 on page 362.

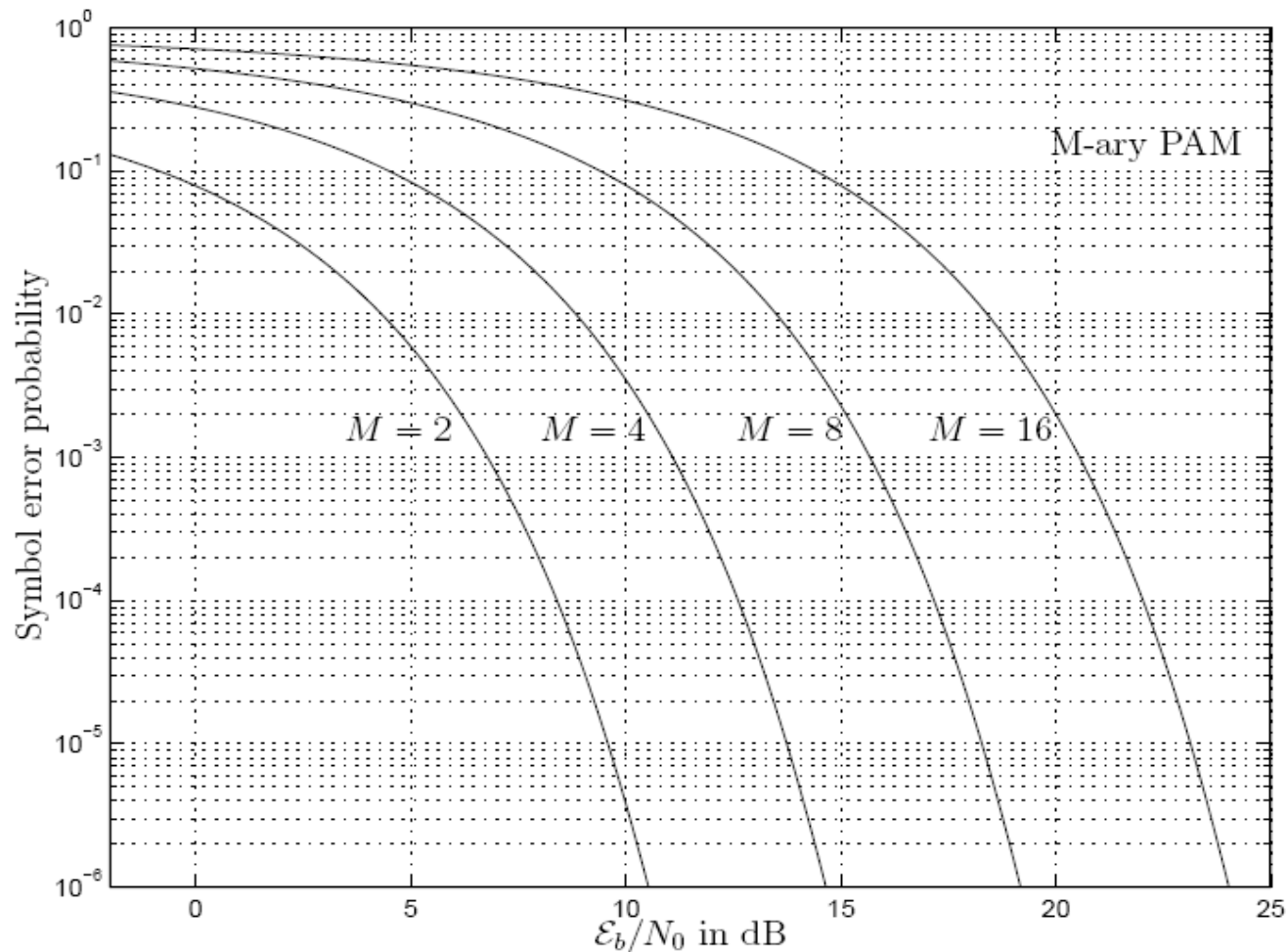
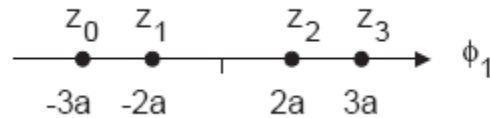

Figure 5.13: The symbol error probability for M-ary PAM,  $M = 2, 4, 8, 16$ , see Table 5.1. The specific assumptions are given in Subsection 2.4.1.1, and in Subsection 5.1.3.



$$5.14 \Pr\{\text{error}|m_0 \text{ sent}\} = \Pr\{w_1 > a/2\} =$$

$$= \Pr\left\{\frac{w_1}{\sqrt{N_0/2}} > \frac{a/2}{\sqrt{N_0/2}}\right\} = Q\left(\sqrt{\frac{a^2}{2N_0}}\right)$$

$$\Pr\{\text{error}|m_1 \text{ sent}\} = \Pr\{w_1 < -a/2 \text{ or } w_1 > 2a\}.$$

So, we obtain

$$P_s = \sum_{j=0}^3 P_j \Pr\{\text{error}|m_j \text{ sent}\} = Q\left(\sqrt{\frac{a^2}{2N_0}}\right) + \frac{1}{2} Q\left(\sqrt{\frac{8a^2}{N_0}}\right)$$