

# ETSF05/ETSF10 – Internet Protocols

SMTP

FTP

TFTP

DNS

SNMP

...

BOOTP

SCTP

## Performance & QoS Congestion Control

TCP

UDP

IGMP

ICMP

IP

ARP

RARP

Underlying LAN or WAN  
technology



# Quality of Service (QoS)

- Maintaining a functioning network
  - Meeting applications' demands
    - User's demands = QoE (Quality of Experience)
  - Dealing with flow characteristics

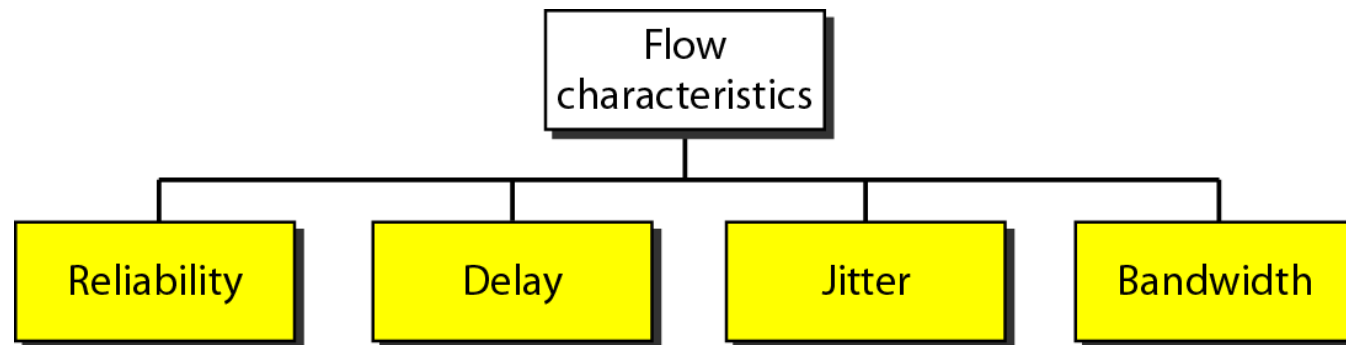

Jitter = Packet Delay Variations

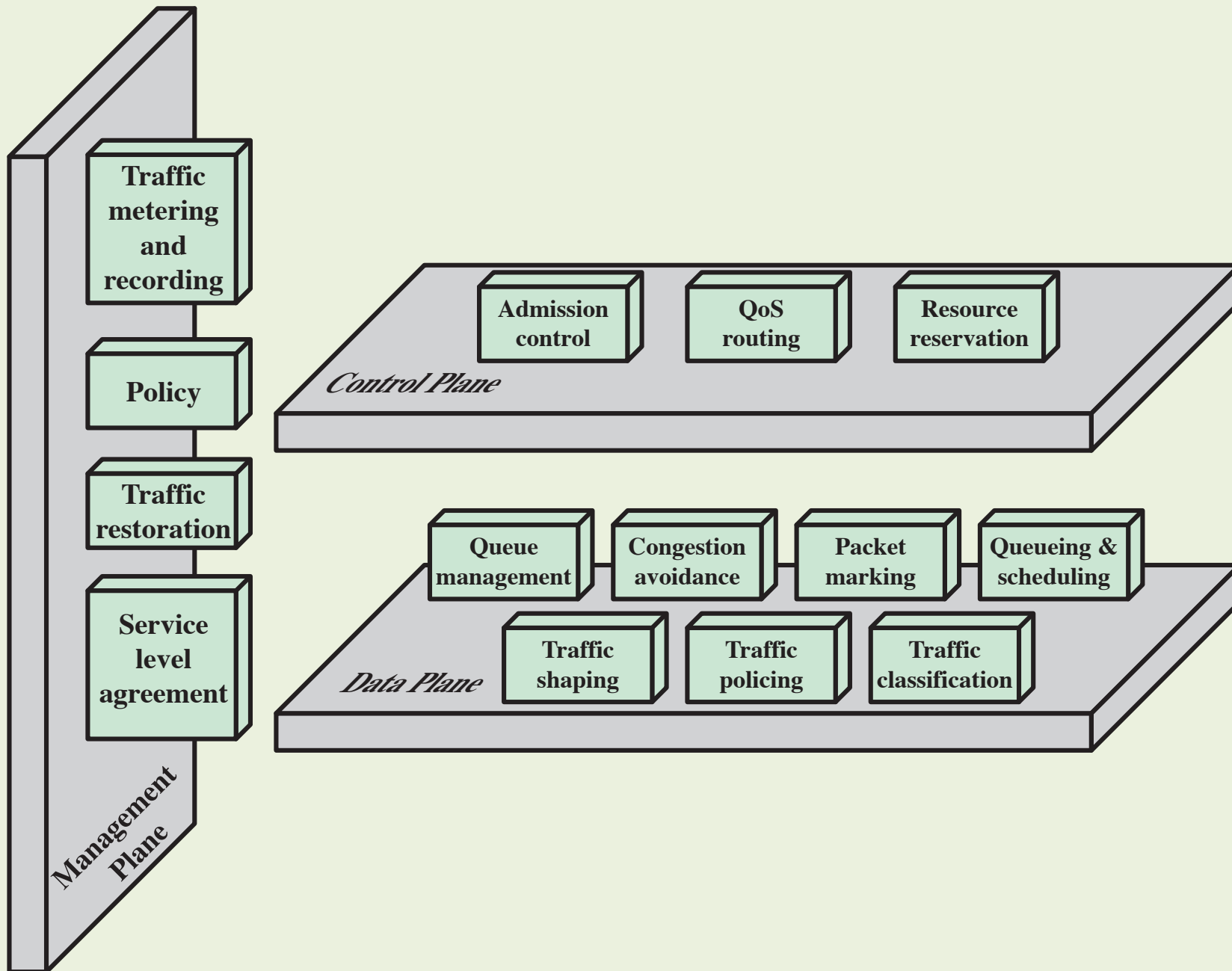

**Figure 22.1 Architectural Framework for QoS Support**

# Data Plane

- Includes those mechanisms that operate directly on flows of data
  - Queue management algorithms
    - Tail drop vs RED (Random Early Detection)
  - Queueing and scheduling
  - Congestion avoidance
  - Packet marking
  - Traffic classification
  - Traffic policing
  - Traffic shaping

# Control Plane

- Concerned with creating and managing the pathways through which user data flows
  - Admission control
  - QoS routing
  - Resource reservation



# Management Plane

- Contains mechanisms that affect both control plane and data plane mechanisms
  - Service level agreement (SLA)
  - Traffic metering and recording
  - Traffic restoration
  - Policy

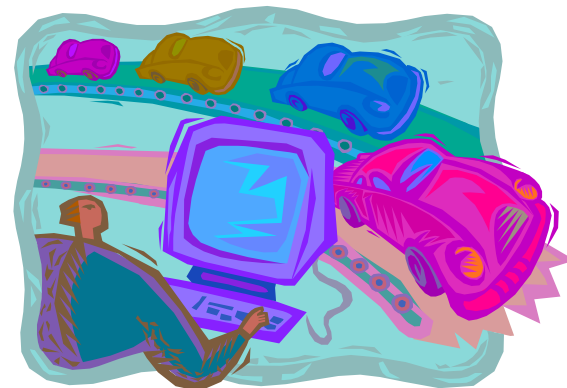

# Network performance

- Data rate (Bandwidth)
  - Bits per second
- Throughput
  - Efficiency, always less than capacity ( $<1$ )
  - Alternatively: available data rate
- Latency (Delay)
  - Transmission, propagation, processing, queueing
  - One way or RTT (Round Trip time)
- PDV = Packet Delay Variation (Jitter)
  - Real-time applications!

# Other parameters

- Bit Error Rate
  - L1 parameter that heavily impacts on L3
  - Frame/Packet Loss on higher layers
- Inter Packet Gap variations
  - “Jitter”
  - Could be non-zero already at sender
- Ratio of packets out of order
  - Impact on delay in TCP



# Packet loss

- Due to
  - Bit error in packet
    - Routers discard erroneous packet
    - Link or Physical Layer?
  - Queue overflow
    - Discard packets
    - Node problems
- In real-time multimedia late packets considered lost
- Packet loss ratio (%)
- Note TCP's sensitivity to packet loss

<b>Circuit Switching</b>	<b>Datagram Packet Switching</b>	<b>Virtual Circuit Packet Switching</b>
Dedicated transmission path	No dedicated path	No dedicated path
Continuous transmission of data	Transmission of packets	Transmission of packets
Fast enough for interactive	Fast enough for interactive	Fast enough for interactive
Messages are not stored	Packets may be stored until delivered	Packets stored until delivered
The path is established for entire conversation	Route established for each packet	Route established for entire conversation
Call setup delay; negligible transmission delay	Packet transmission delay	Call setup delay; packet transmission delay
Busy signal if called party busy	Sender may be notified if packet not delivered	Sender notified of connection denial
Overload may block call setup; no delay for established calls	Overload increases packet delay	Overload may block call setup; increases packet delay
Electromechanical or computerized switching nodes	Small switching nodes	Small switching nodes
User responsible for message loss protection	Network may be responsible for individual packets	Network may be responsible for packet sequences
Usually no speed or code conversion	Speed and code conversion	Speed and code conversion
Fixed bandwidth	Dynamic use of bandwidth	Dynamic use of bandwidth
No overhead bits after call setup	Overhead bits in each packet	Overhead bits in each packet

**Table 9.1**  
**Comparison of Communication Switching Techniques**

(Table can be found on page 315 in textbook)

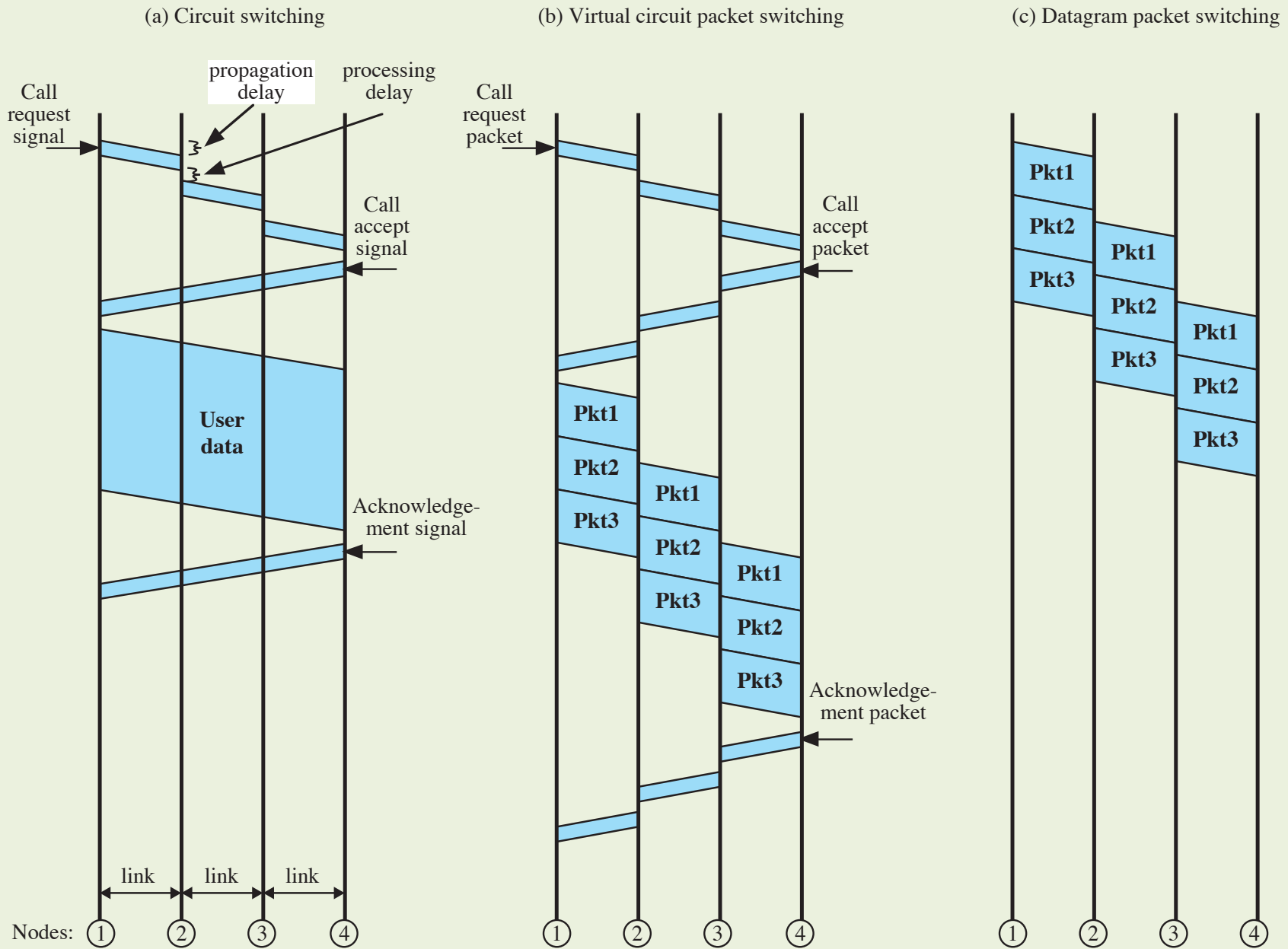

**Figure 9.15 Event Timing for Circuit Switching and Packet Switching**

# Virtual Circuits vs. Datagram

- Virtual circuits
  - Network can provide sequencing and error control
  - Packets are forwarded more quickly
  - Less reliable (compare Circuit Switching)
- Datagram (Best Effort)
  - No call setup phase
  - Individual packet handling
  - More flexible
  - More reliable



# IP Performance Metrics (IPPM wg)

- Chartered by IETF to develop standard metrics that relate to the quality, performance, and reliability of Internet data delivery
- Measurement techniques
  - **Active:** Transmit packets over network for measurement purposes
  - **Passive:** Use existing traffic for measurements

# Table 22.3

## IP Performance Metrics

Metric Name	Singleton Definition	Statistical Definitions
One-Way Delay	Delay = $dT$ , where Src transmits first bit of packet at T and Dst received last bit of packet at T + $dT$	Percentile, median, minimum, inverse percentile
Round-Trip Delay	Delay = $dT$ , where Src transmits first bit of packet at T and Src received last bit of packet immediately returned by Dst at T + $dT$	Percentile, median, minimum, inverse percentile
One-Way Loss	Packet loss = 0 (signifying successful transmission and reception of packet); = 1 (signifying packet loss)	Average
One-Way Loss Pattern	Loss distance: Pattern showing the distance between successive packet losses in terms of the sequence of packets  Loss period: Pattern showing the number of bursty losses (losses involving consecutive packets)	Number or rate of loss distances below a defined threshold, number of loss periods, pattern of period lengths, pattern of inter-loss period lengths.
Packet Delay Variation	Packet delay variation (pdv) for a pair of packets with a stream of packets = difference between the one-way-delay of the selected packets	Percentile, inverse percentile, jitter, peak-to-peak pdv

Src = IP address of a host  
Dst = IP address of a host

# Table 22.3

## IP Performance Metrics

Metric Name	General Definition	Metrics
Connectivity	Ability to deliver a packet over a transport connection.	One-way instantaneous connectivity, Two-way instantaneous connectivity, one-way interval connectivity, two-way interval connectivity, two-way temporal connectivity
Bulk Transfer Capacity	Long-term average data rate (bps) over a single congestion-aware transport connection.	$BTC = (\text{data sent})/(\text{elapsed time})$

### (b) Other metrics

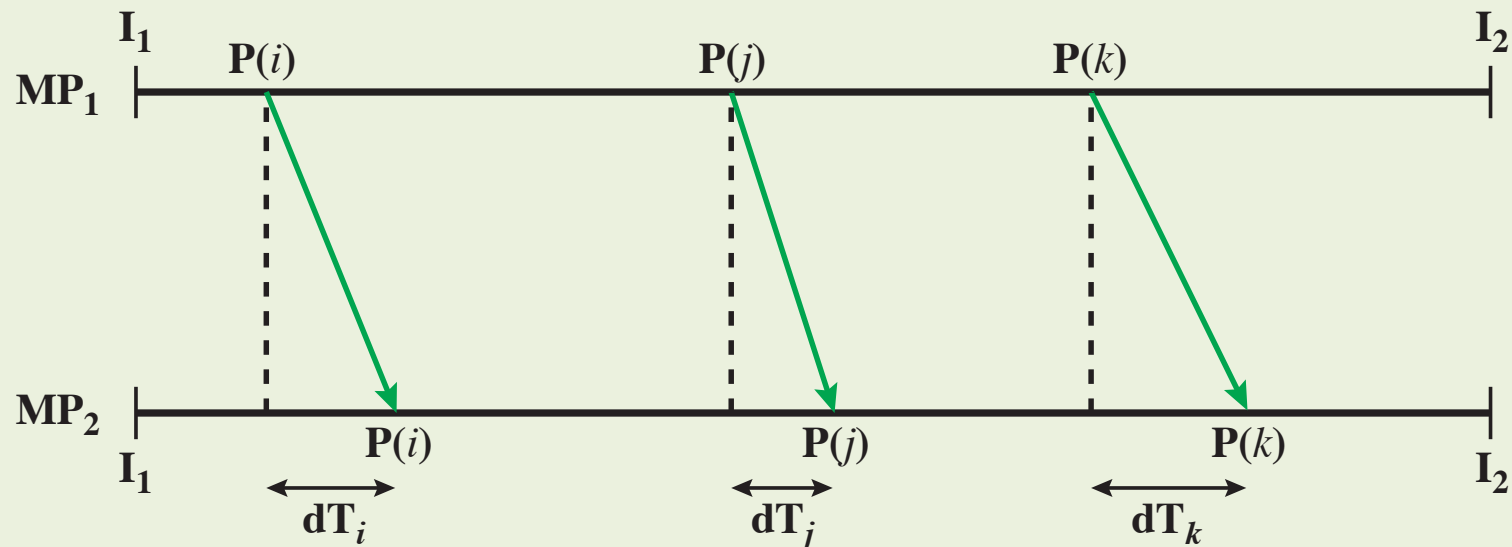

$I_1, I_2$  = times that mark the beginning and ending of the interval in which the packet stream from which the singleton measurement is taken occurs.

$MP_1, MP_2$  = source and destination measurement points

$P(i)$  =  $i$ th measured packet in a stream of packets

$dT_i$  = one-way delay for  $P(i)$  → Time synch!

$$PDV_i = dT_i - dT_{i-1}$$

Alt.  
 $STD(dT)$

**Figure 22.12 Model for Defining Packet Delay Variation**



# Bandwidth-delay product

- How much data fills the link
- One Way Delay
- Two Way Delay = Round Trip Time (RTT)  
Time for data + time for ACK

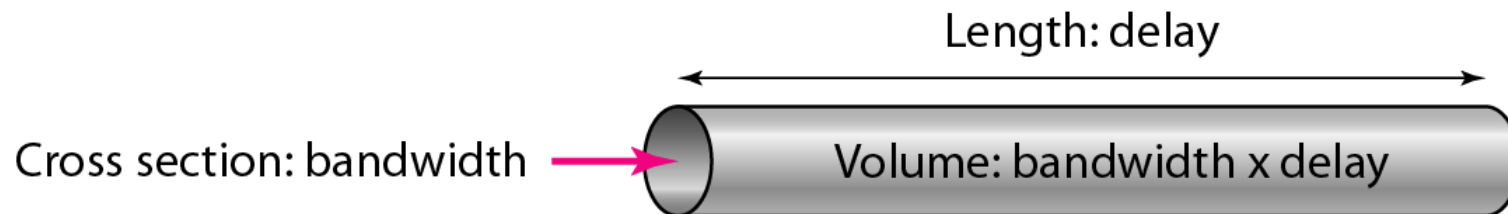

# Bandwidth-delay product

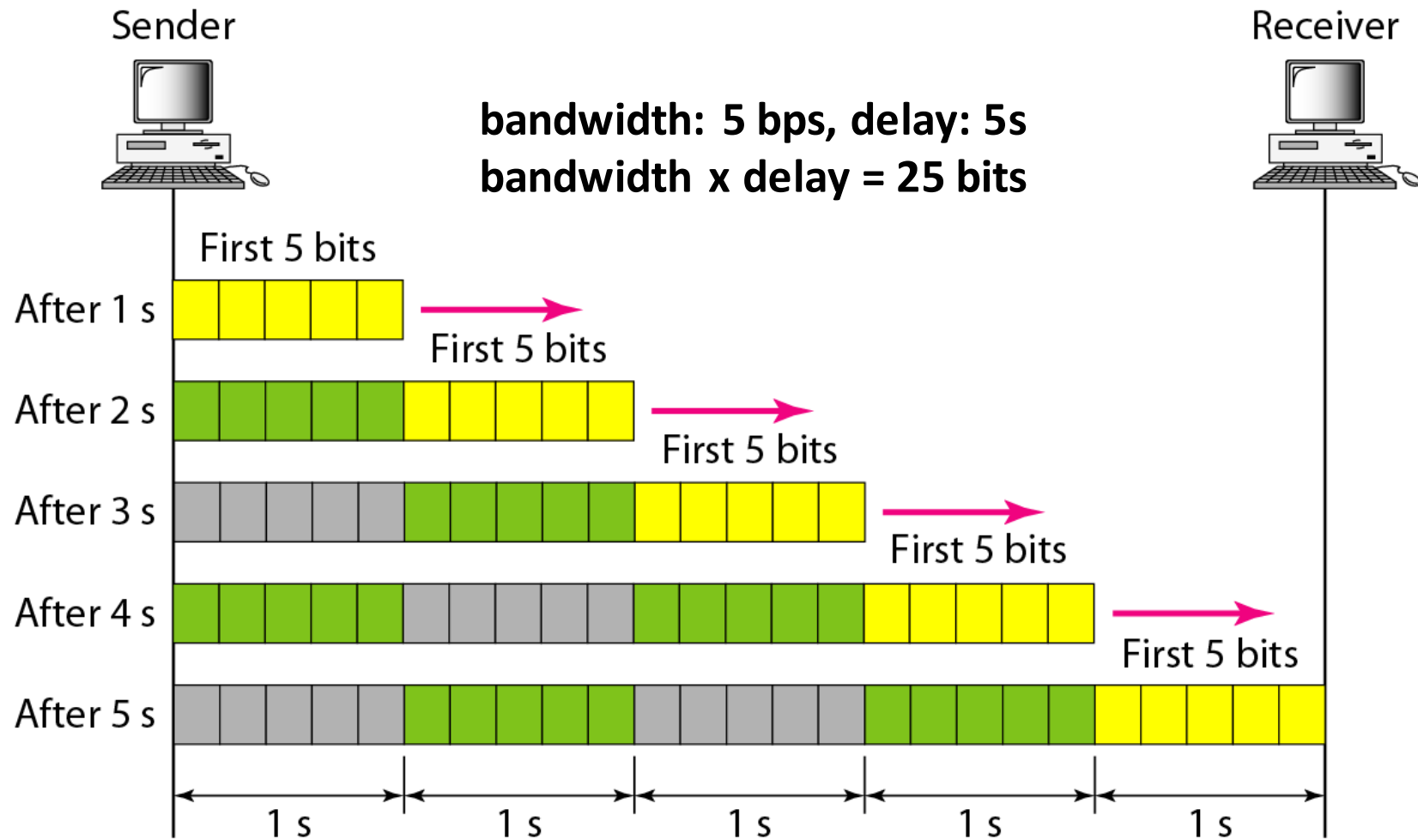

# Bandwidth-delay product

- Important for congestion avoidance
  - Don't overfill the link
- Important for efficiency
  - Keep the link filled at all times
  - For max efficiency
    - Data chunks  $> 2 * \text{bandwidth} * \text{delay}$

# Bandwidth-delay product

- Important for tuning (TCP)
- Long Fat Network (LFN, "elephant")  
BDP  $\gg 10^5$  bits
- Very long (high delay) links:
  - > Bandwidth = BDP/delay
  - But it takes long time before ACK arrives ...

# Performance vs ARQ

- Method
  - Stop-&-Wait
  - Go-Back-N
  - Selective-Repeat
- Utilisation =  $f(\text{window size})$

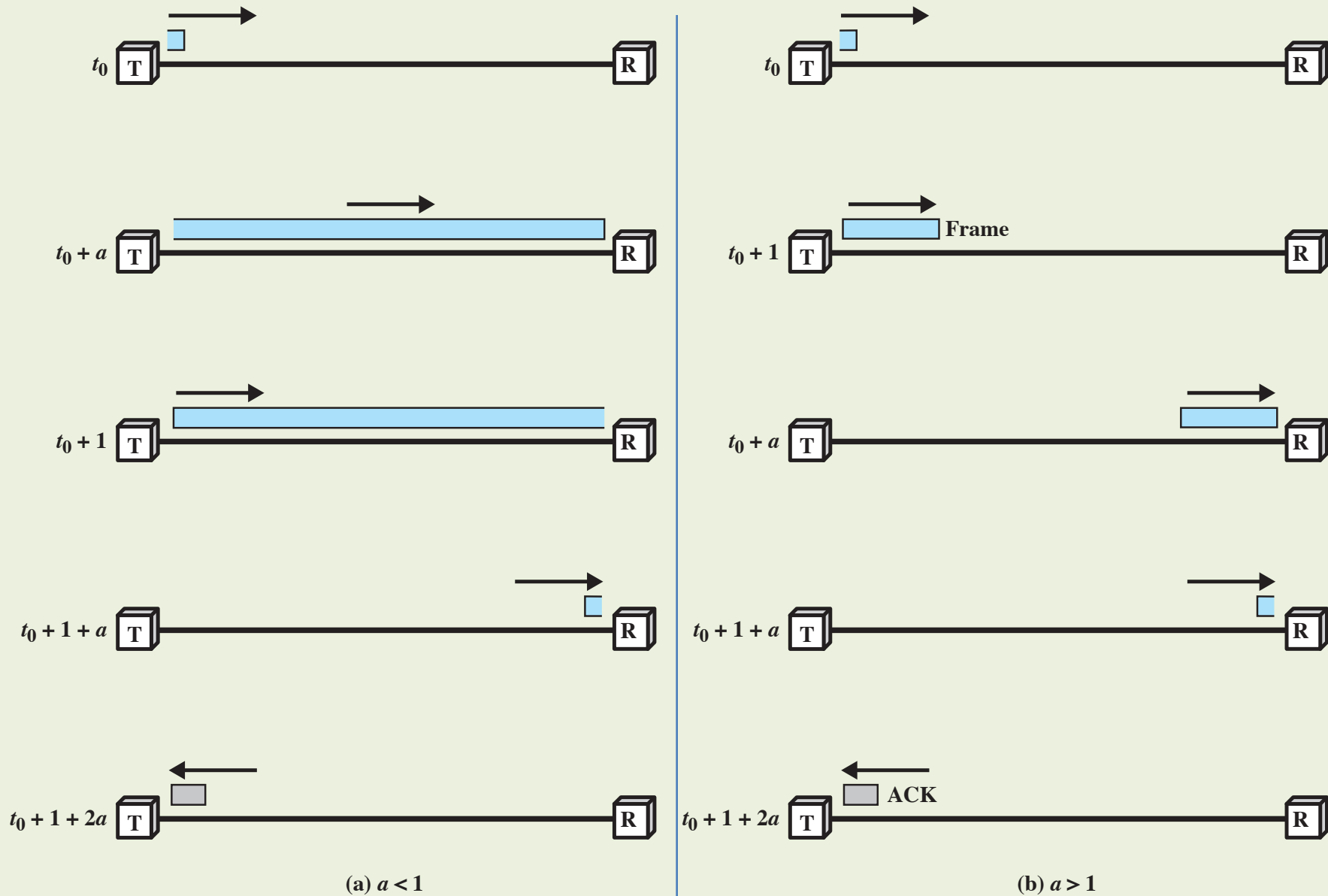

**Figure 16.8 Stop-and-Wait Link Utilization (transmission time = 1; propagation time =  $a$ )**

# Sliding Windows based

- $a$  = propagation time
- $W$  = window size
- Compare with Bandwidth-Delay Product

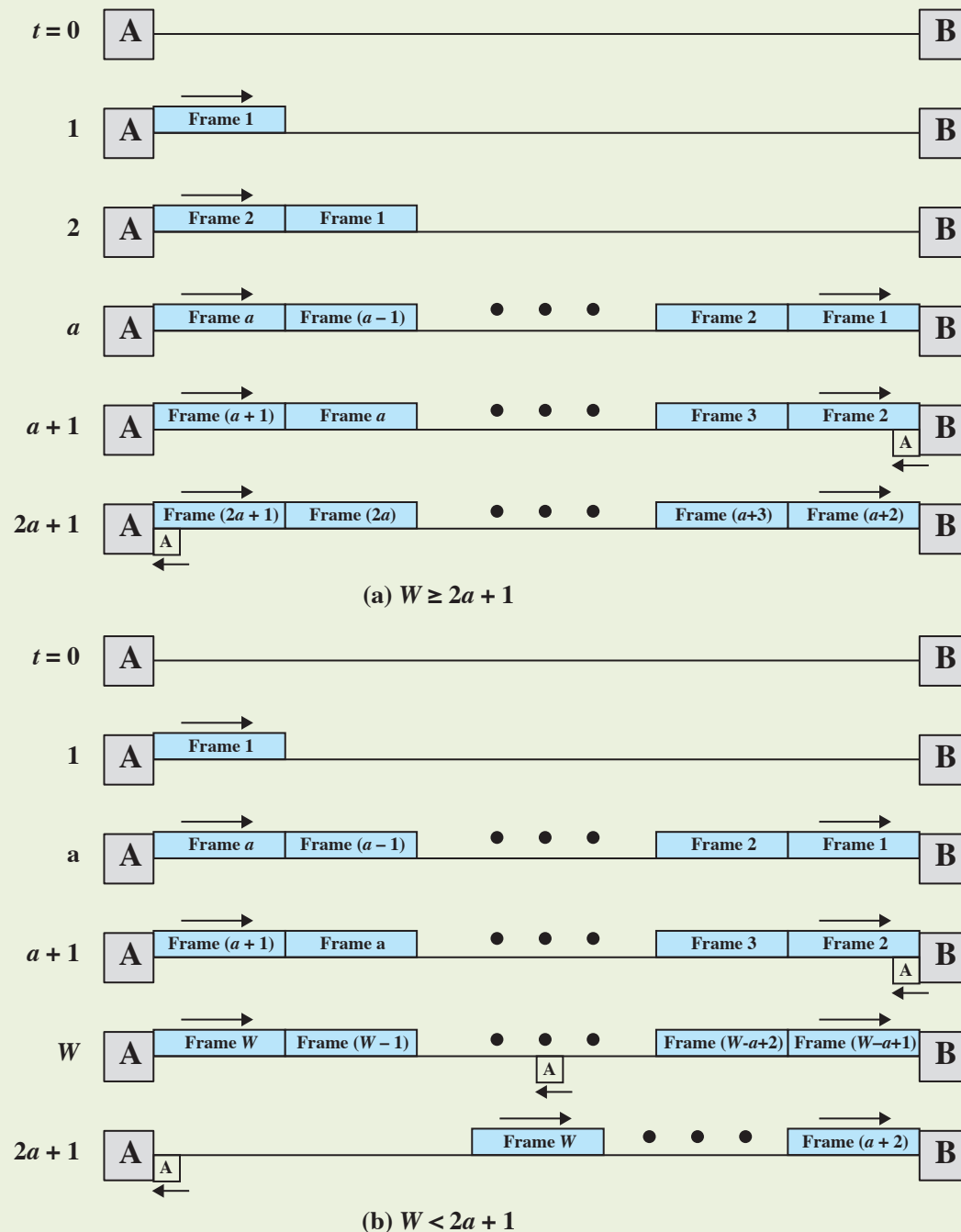
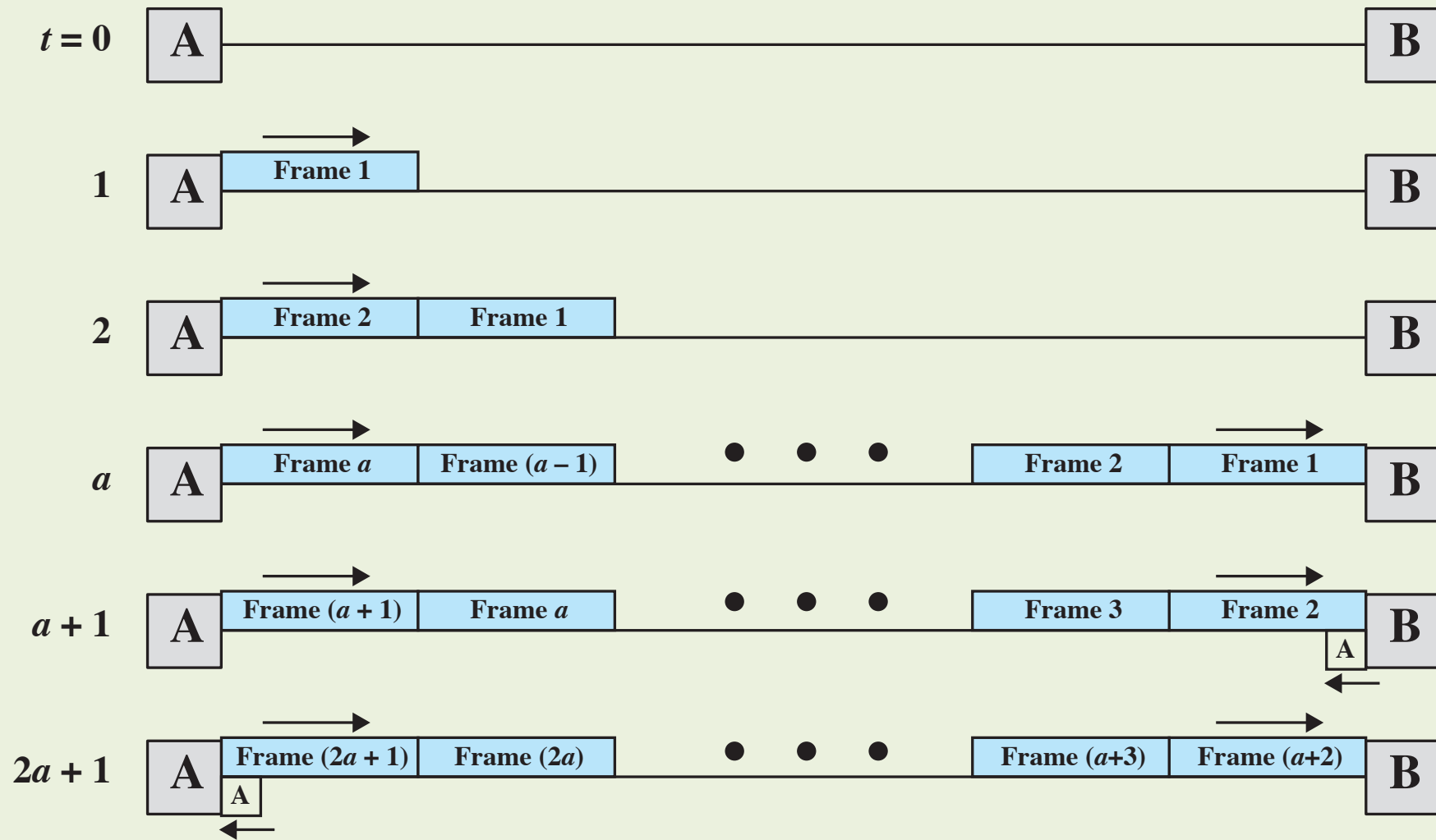
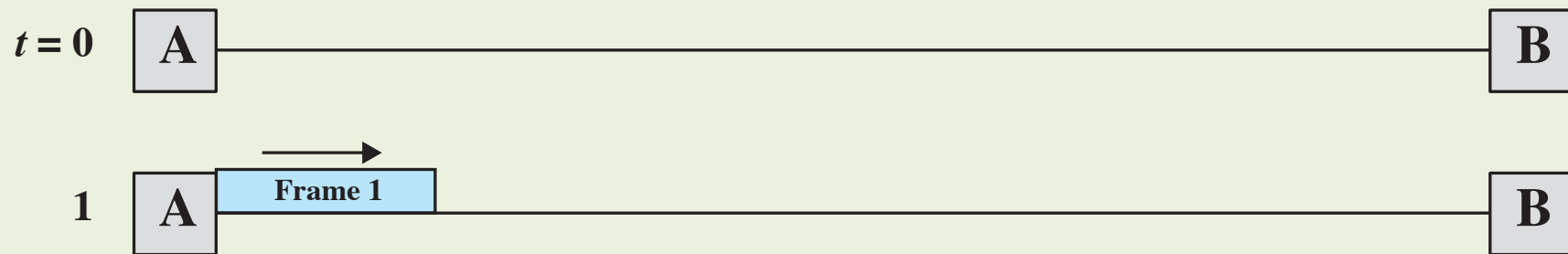

Figure 16.9 Timing of Sliding-Window Protocol - Internet Protocols



(a)  $W \geq 2a + 1$





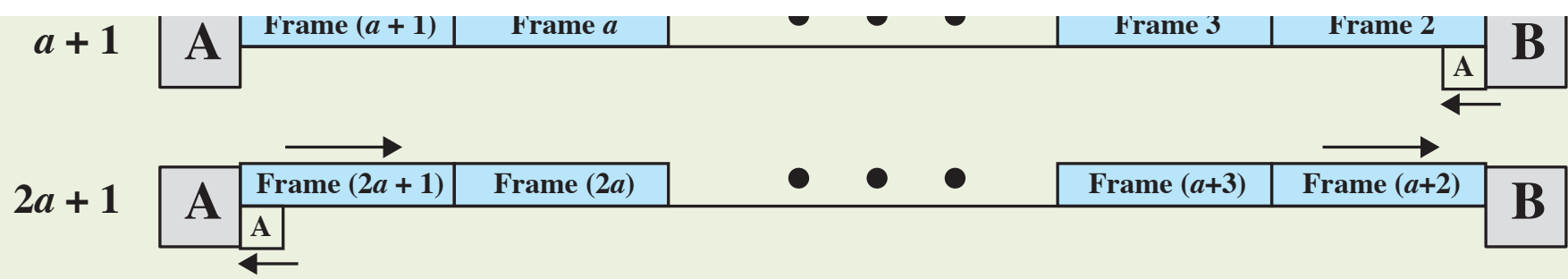

(a)  $W \geq 2a + 1$

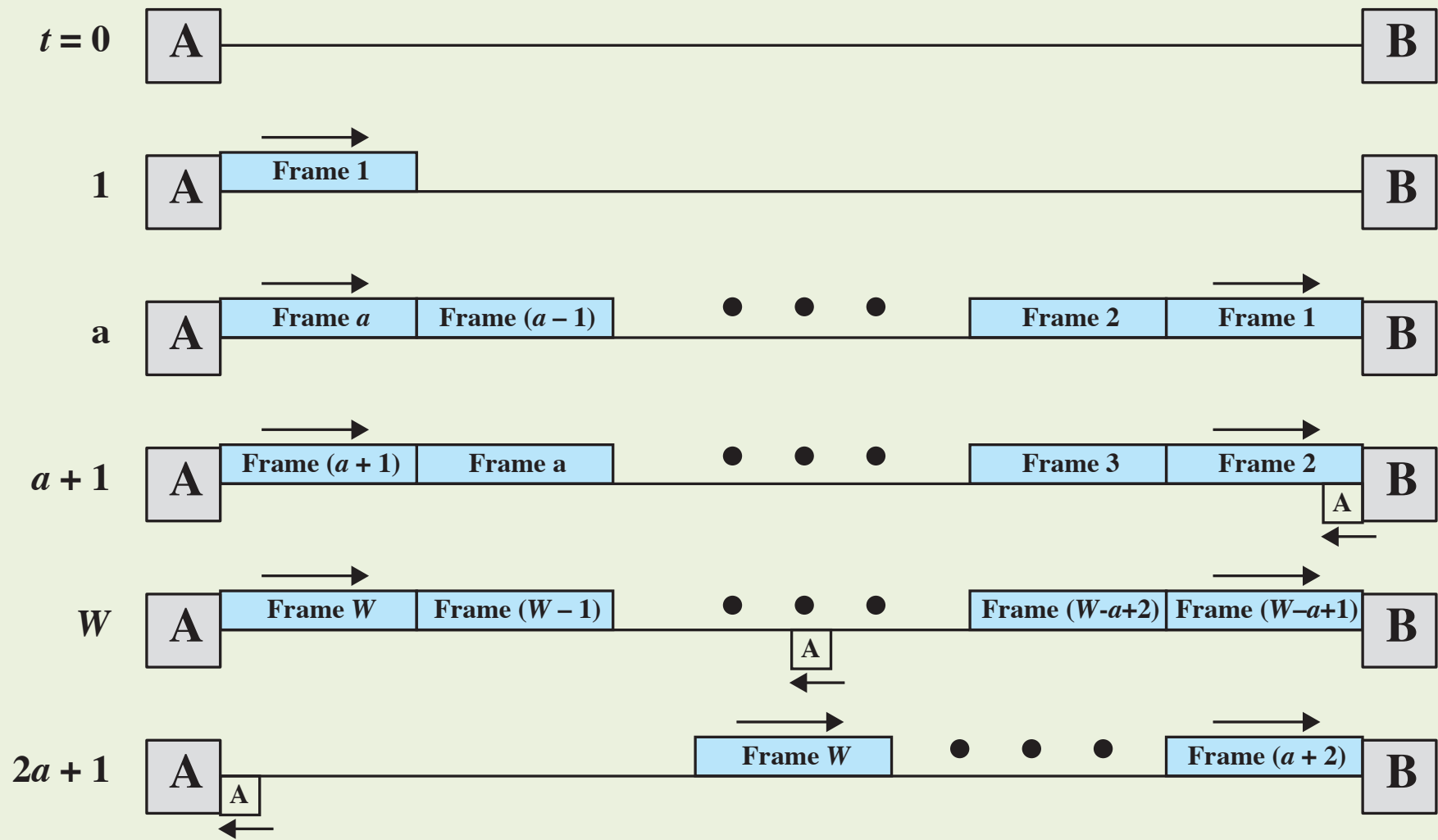

(b)  $W < 2a + 1$

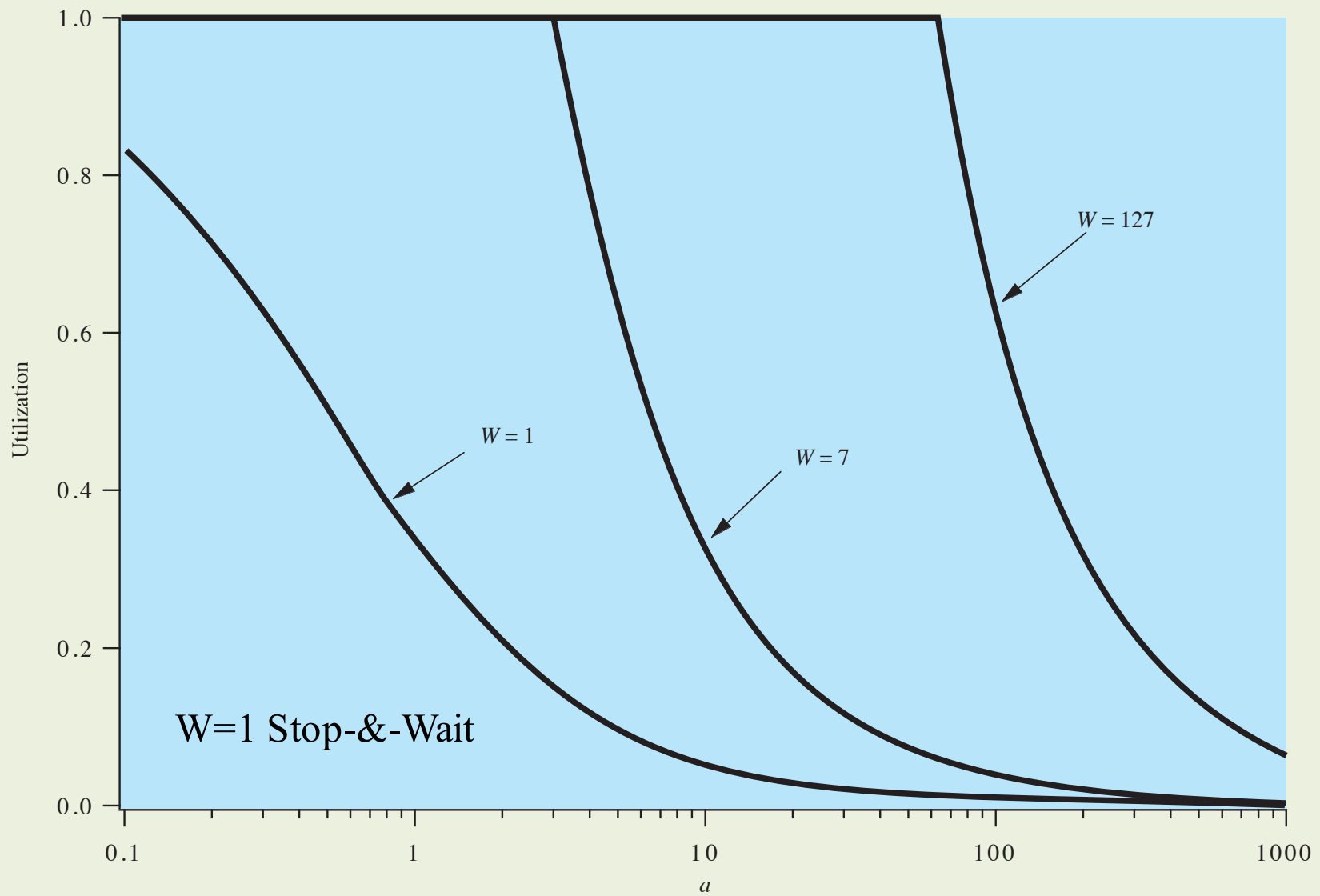

**Figure 16.10 Sliding-Window Utilization as a function of  $a$**

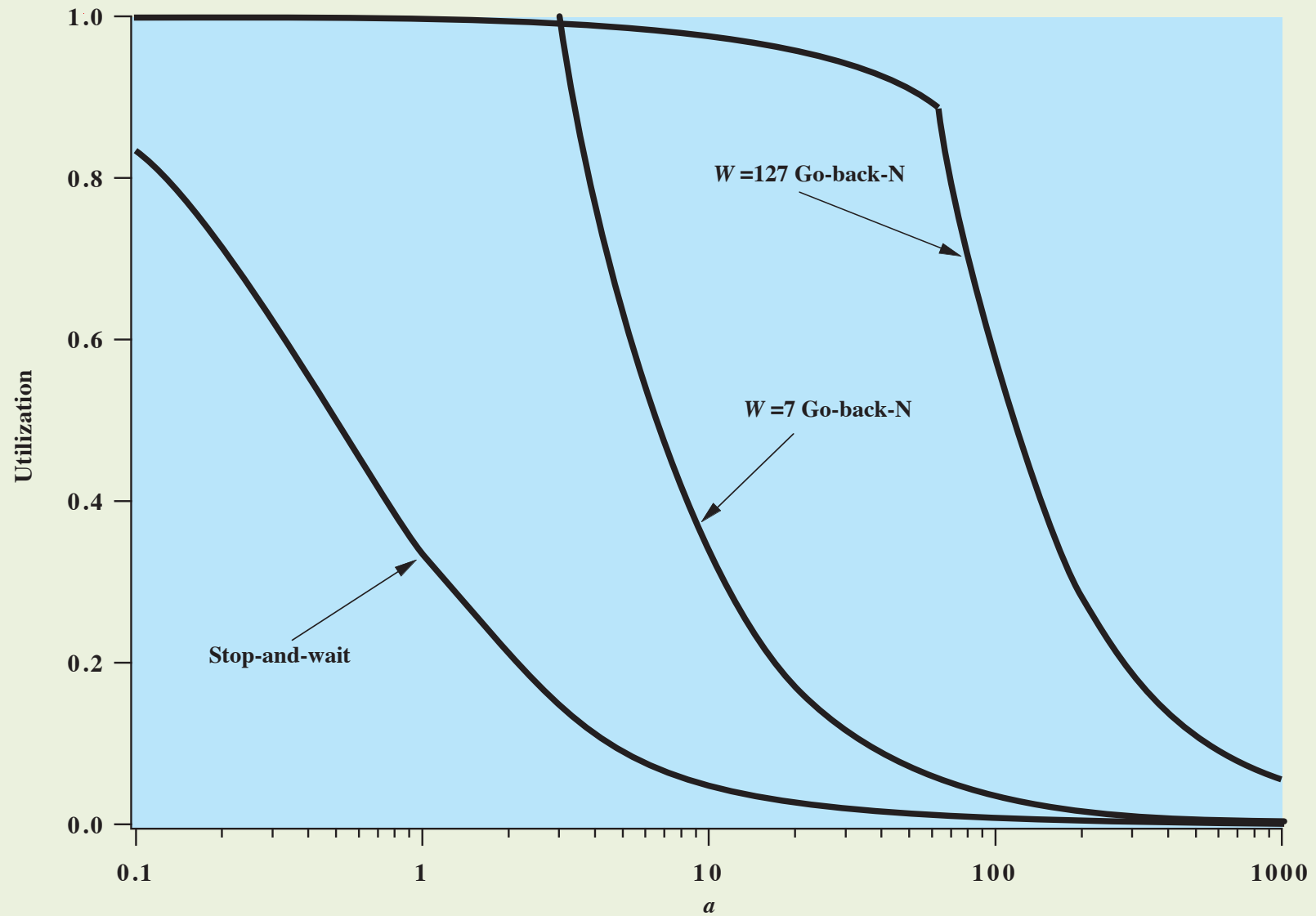
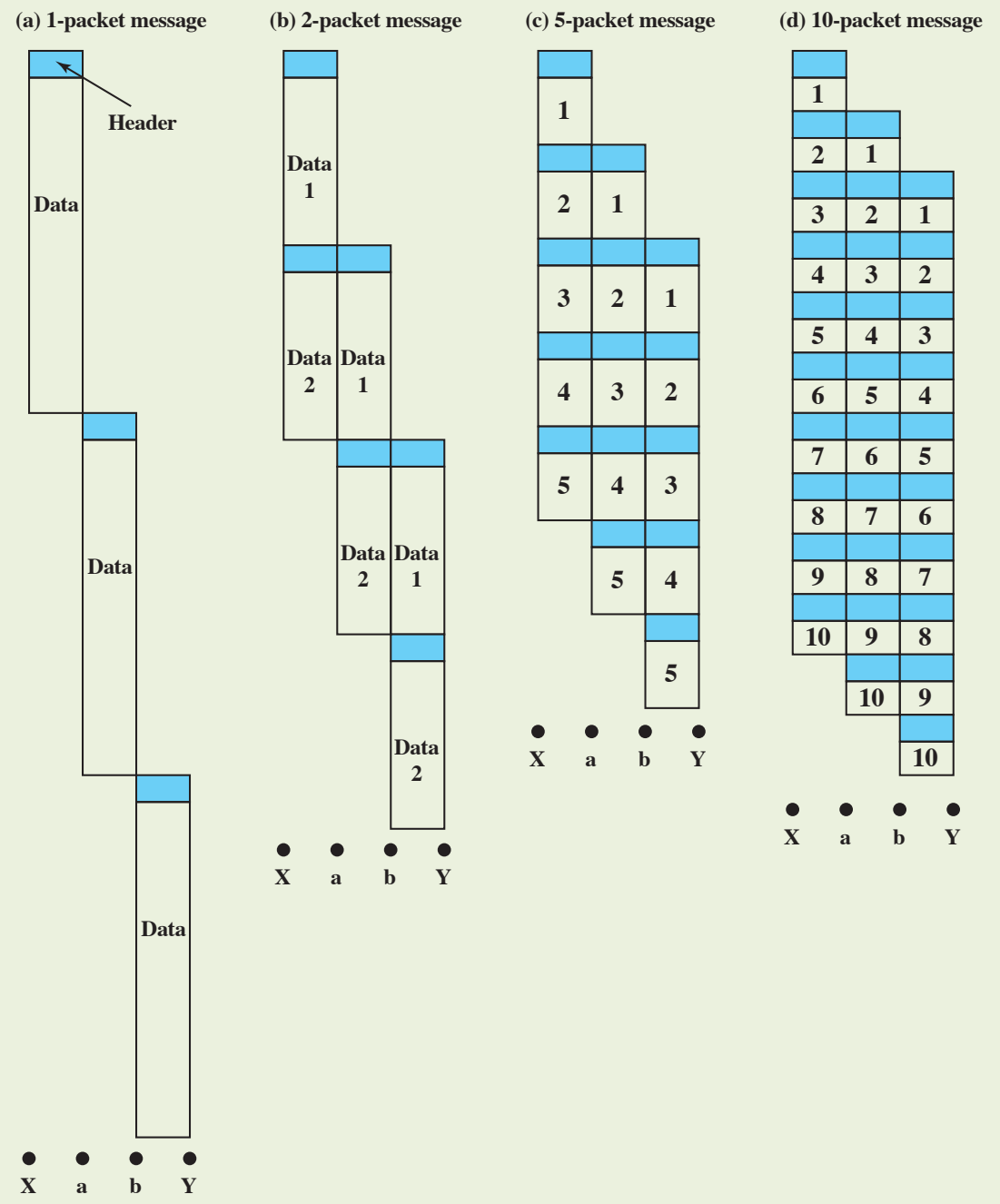

Figure 16.11 ARQ Utilization as a Function of  $a$  ( $P = 10^{-3}$ )

# Packet Size vs Transmission Time



ETSF05/ETSF16 - Internet Protocols **Figure 9.13 Effect of Packet Size on Transmission Time** 29

# Delay and throughput: Finite buffers No congestion control

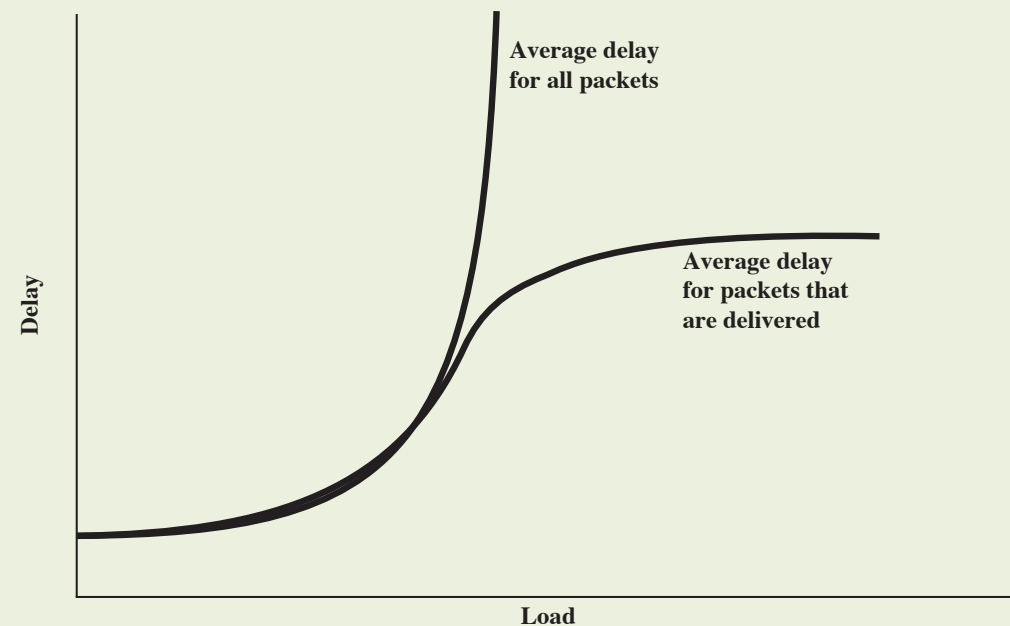
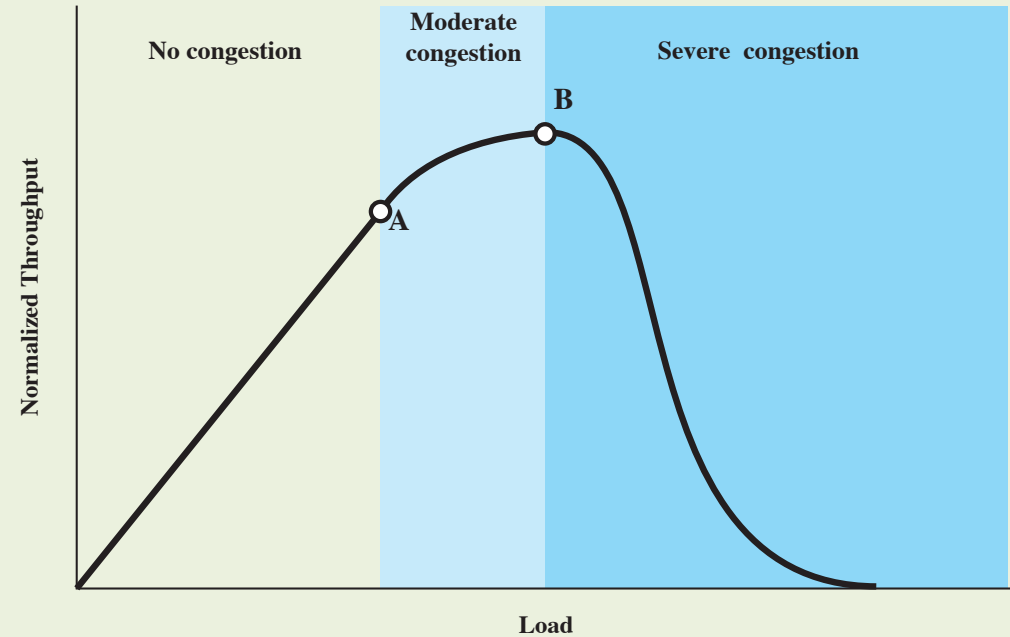

Figure 20.4 The Effects of Congestion

# Congestion Control in Packet-Switching Networks

Send control packet to some or all source nodes

- Requires additional traffic during congestion

Rely on routing information

- May react too quickly

End to end probe packets

- Adds to overhead

Add congestion information to packets in transit

- Either backwards or forwards

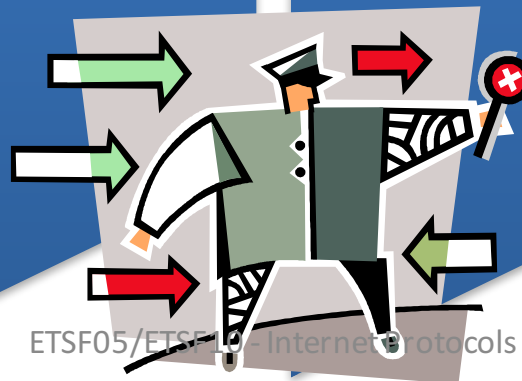

# Explicit Congestion Signaling

- Backward
  - Congestion avoidance notification in opposite direction to packet required
- Forward
  - Congestion avoidance notification in same direction as packet required

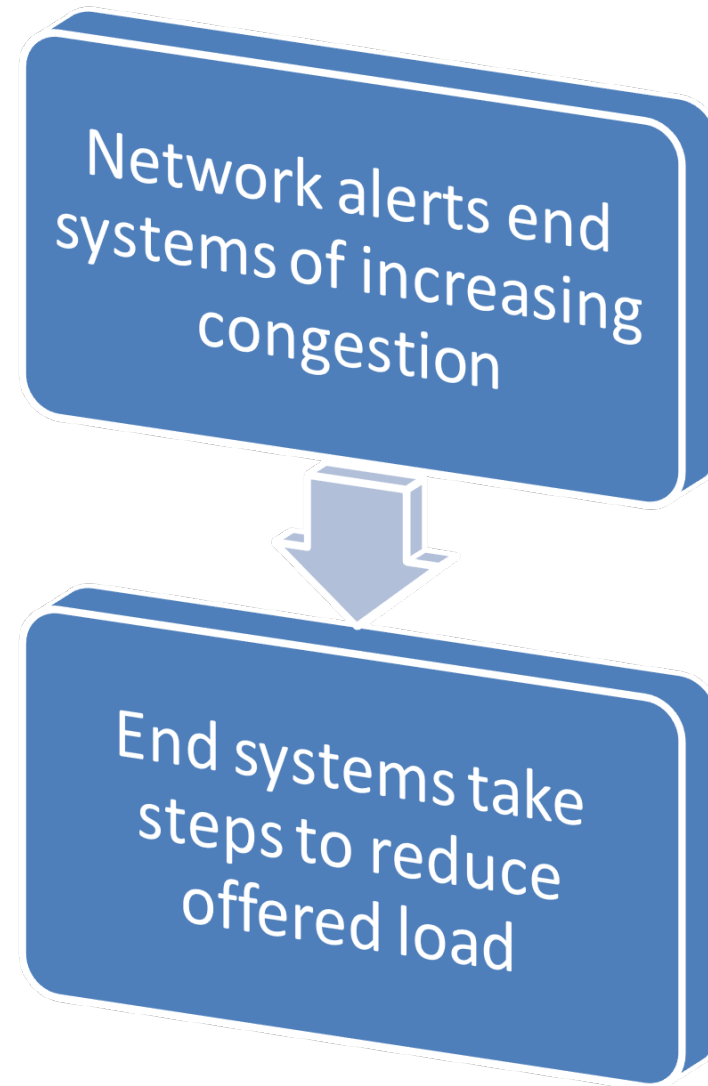

# Congestion control

- Avoiding and eliminating congestion
  - Open-loop = proactive, prevent congestion
  - Closed-loop = reactive, control congestion

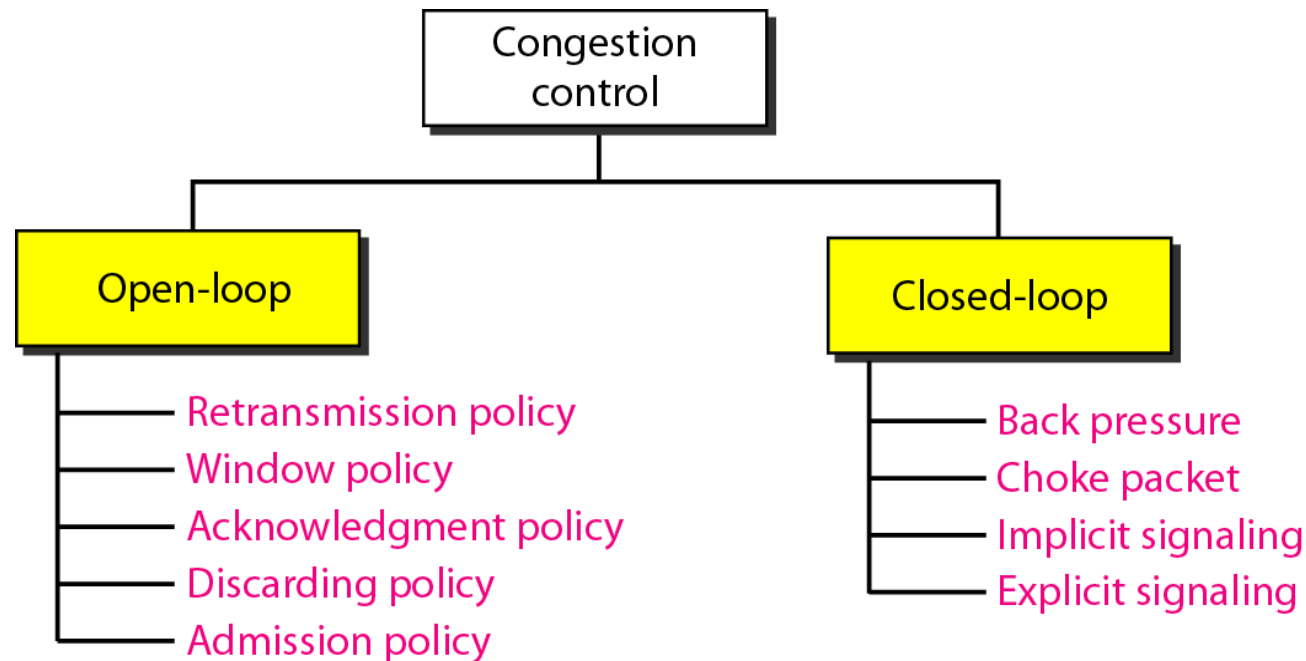



# Closed-loop congestion control (1)

- Backpressure

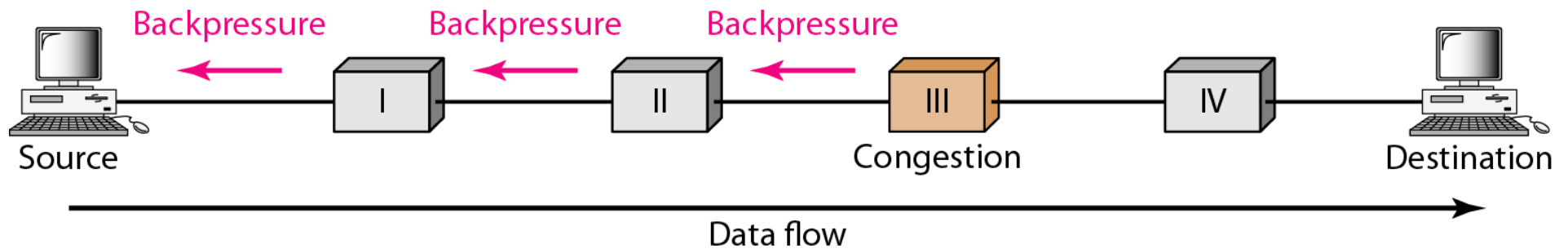

# Closed-loop congestion control (2)

- Choke packet

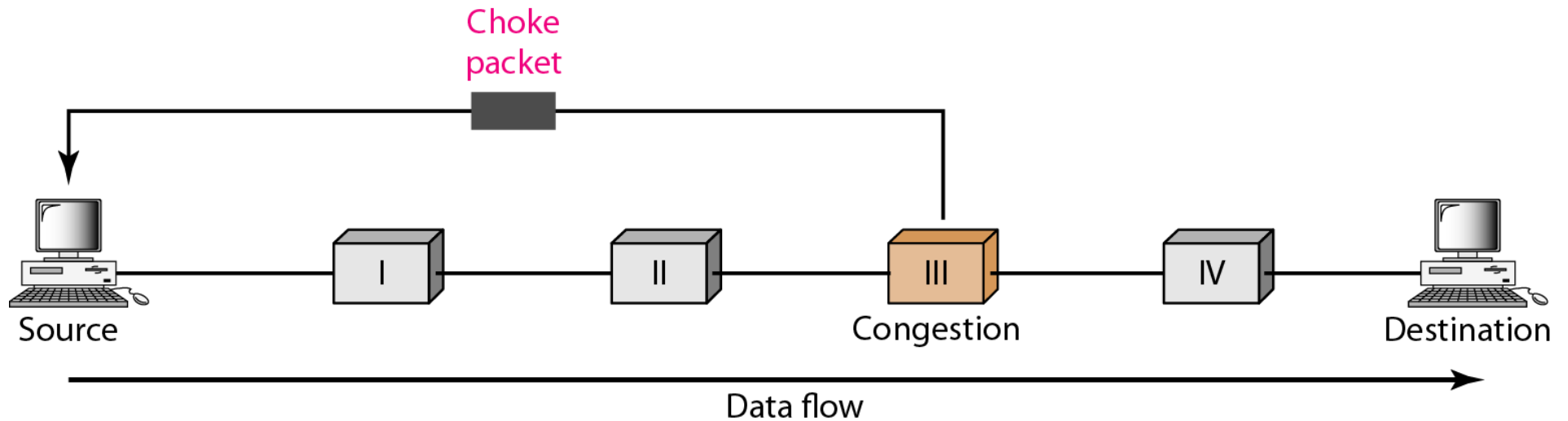

# Implicit Congestion Signaling

- With network congestion:
  - Transmission delay increases
  - Packets may be discarded (Packet loss)
- Source can detect congestion and reduce flow
- Responsibility of end systems
- Effective on connectionless (datagram) networks
- Also used in connection-oriented networks

# Explicit Signaling Categories

- Binary
  - A bit set in a packet indicates congestion
- Credit based
  - Indicates how many packets source may send
  - Common for end-to-end flow control
- Rate based
  - Supply explicit data rate limit
  - Nodes along path may request rate reduction

# How to improve QoS?

- Admission control
- Resource reservation
- **Scheduling**
- **Traffic shaping**
  
- **Routing?**

# Where to improve QoS?

- Admission control
  - DIFFSERV: Service classes
  - INTSERV: Reservation architectures
- Resource reservation
  - RSVP (Resource Reservation Protocol)

- Scheduling
- Traffic shaping

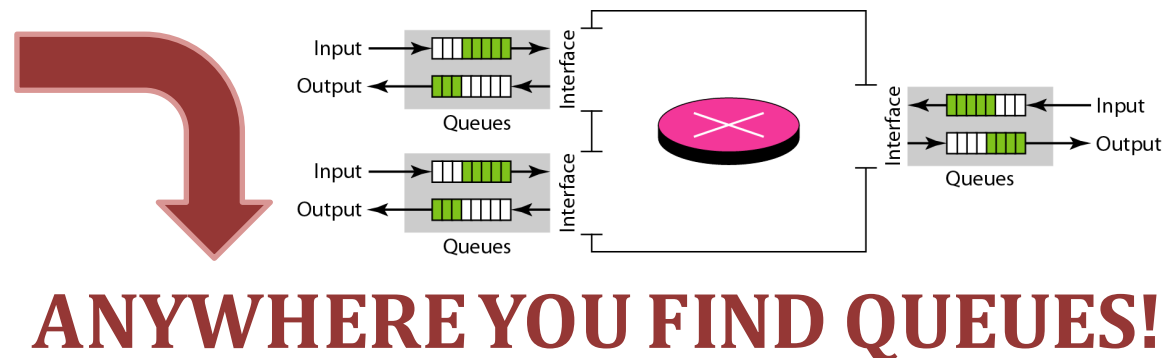

# Scheduling: *FIFO queuing*

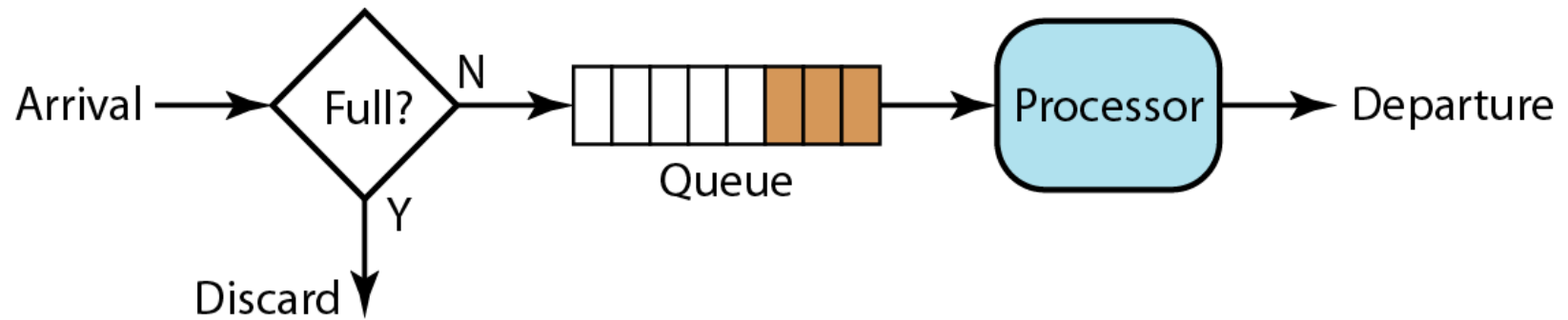

# Scheduling: *Priority queuing*

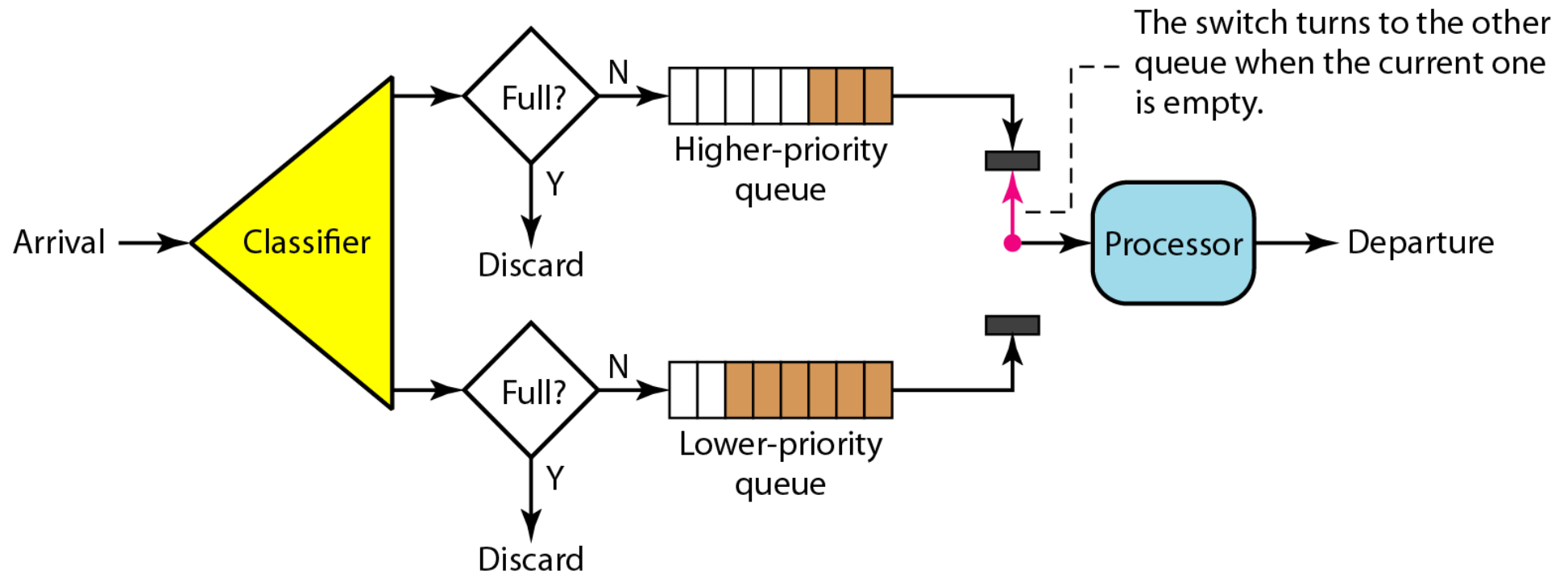



# Scheduling: *Weighted fair queuing*

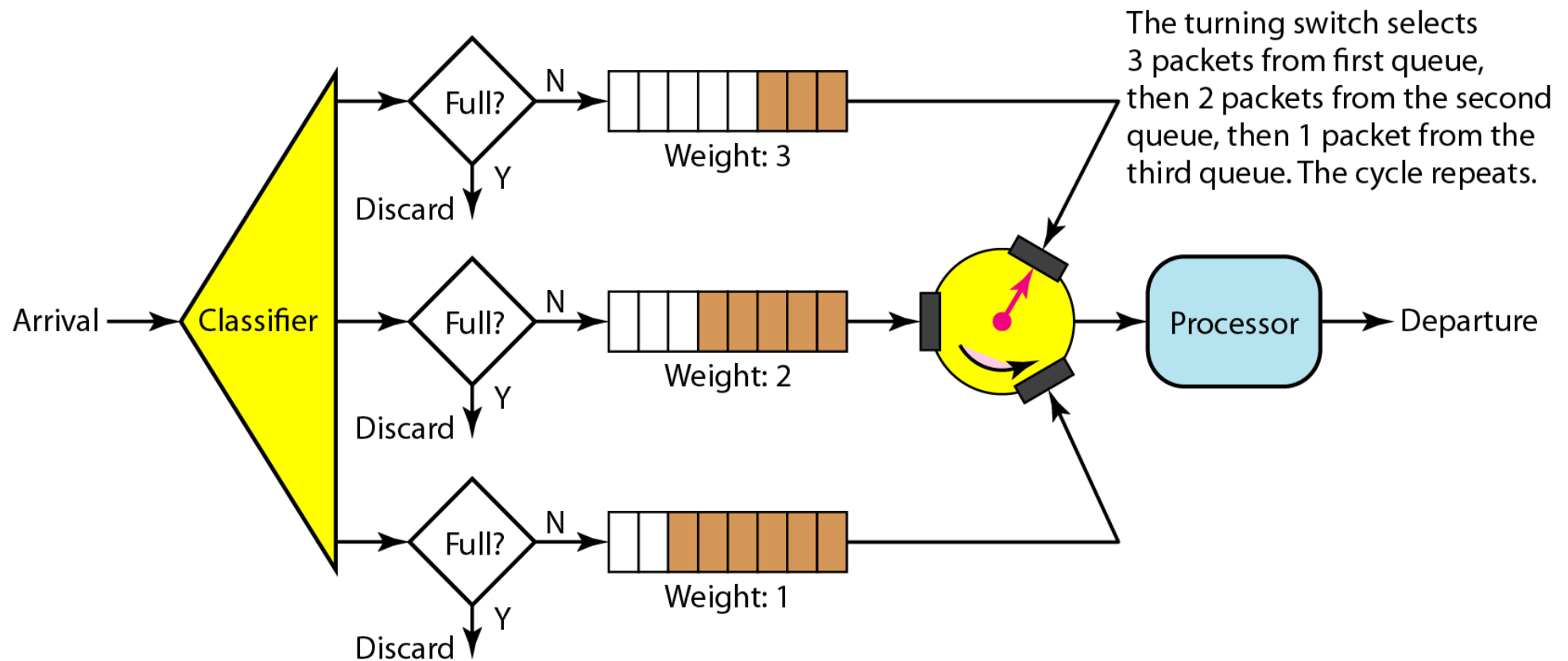

# Traffic Shaping/Traffic Policing

- Two important tools in network management:
  - **Traffic shaping**
    - Concerned with traffic leaving the switch
    - Reduces packet clumping
    - Produces an output packet stream that is less burst and with a more regular flow of packets
  - **Traffic policing**
    - Concerned with traffic entering the switch
    - Packets that don't conform may be treated in one of the following ways:
      - Give the packet lower priority compared to packets in other output queues
      - Label the packet as nonconforming by setting the appropriate bits in a header
      - Discard the packet



# Traffic Management

- Fairness
  - Provide equal treatment of various flows
- Quality of service
  - Different treatment for different flows
- Reservations
  - Traffic contract between user and network
  - Excess traffic discarded or handled on a best-effort basis

# Support from routing protocols?

## *Yes!*

- Optimal path
  - Single metric
  - Multiple metrics?
- Multiple Equal Cost Paths
  - Load sharing
  - Load balancing
- QoS routing
  - Cross-layer approaches
  - OSPF extensions (RFC2676)

## *Well, sort of!*

- Applies to all traffic
  - No differentiation between flow types
- What about inter-domain?
  - No control over network resources
- More sophisticated mechanisms needed
  - Multiprotocol Label Switching (MPLS)
  - Resource Reservation

# Layer 3 congestion avoidance

- Congestion = data load > network capacity
  - Arrival rate > processing rate
  - Processing rate > departure rate
- A simple method
  - Random early discard (RED)
  - UDP?

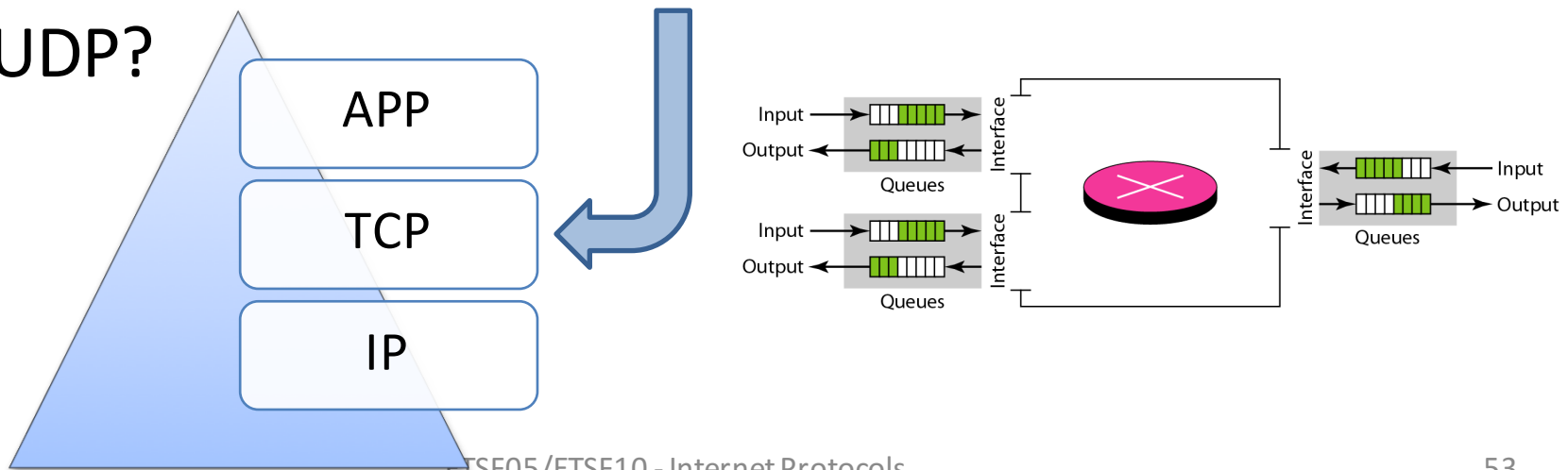

# Traffic descriptors

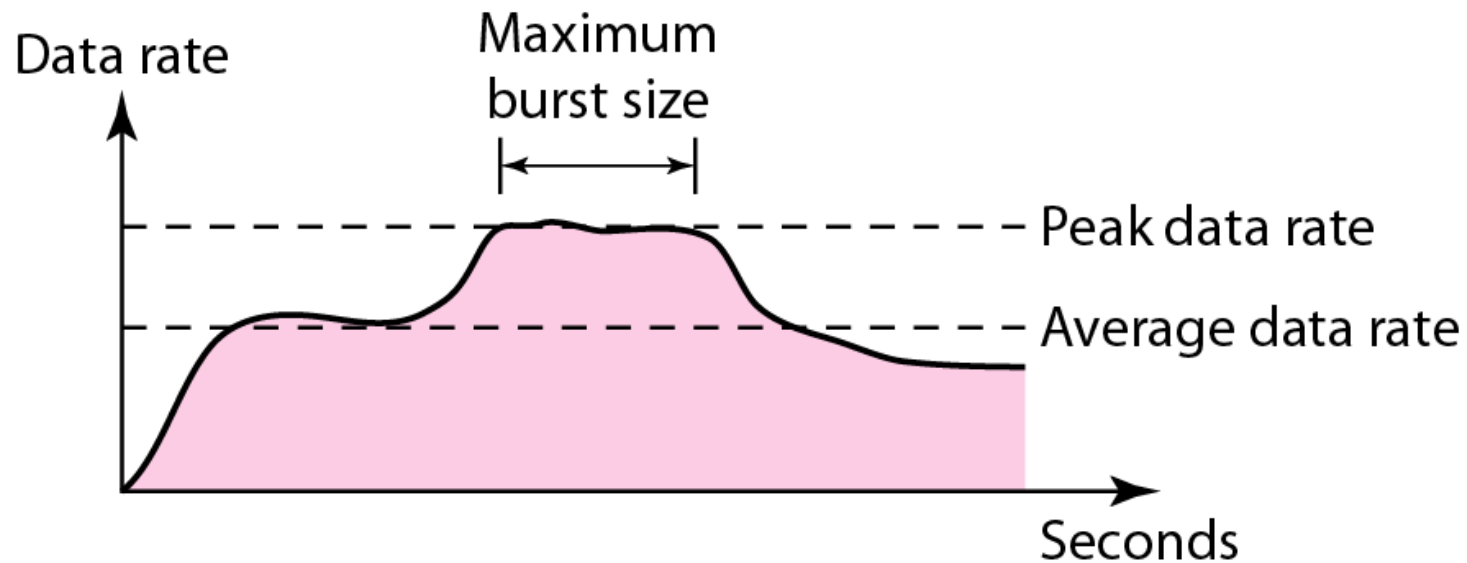

**Effective bandwidth  
requirement**

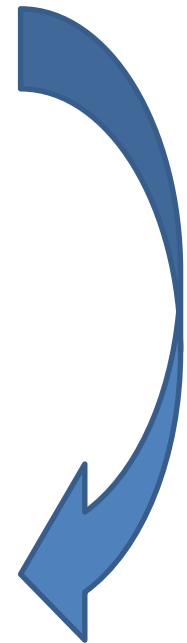

# Traffic profiles

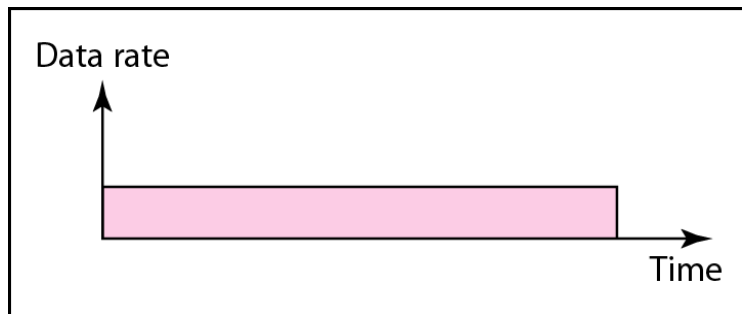

a. Constant bit rate

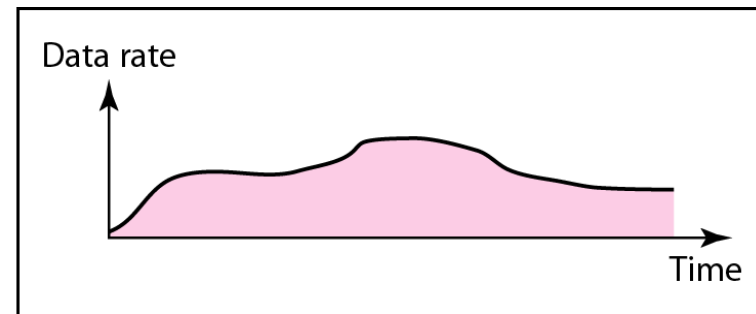

b. Variable bit rate

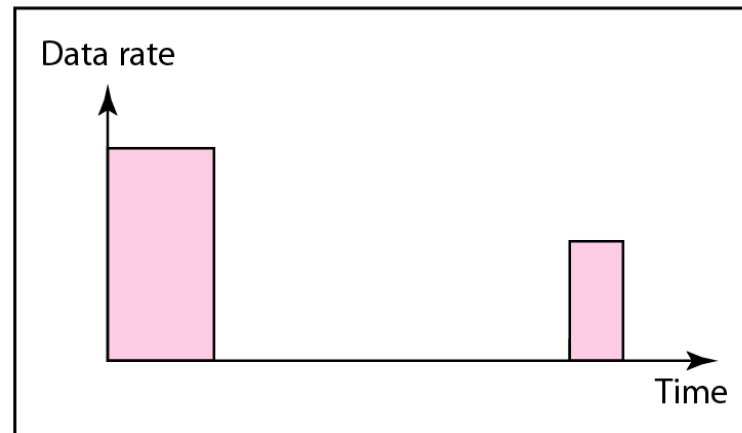

c. Bursty

# Traffic shaping: *Two approaches*

## *Leaky bucket*

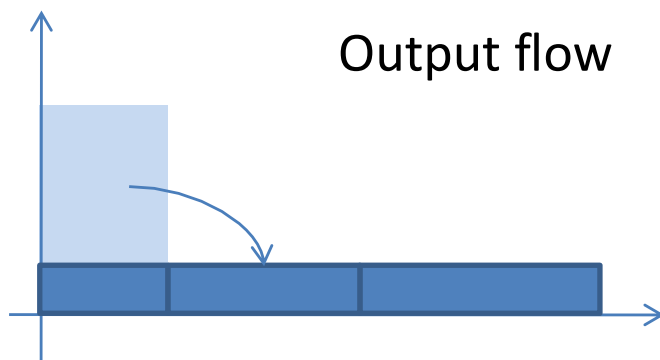
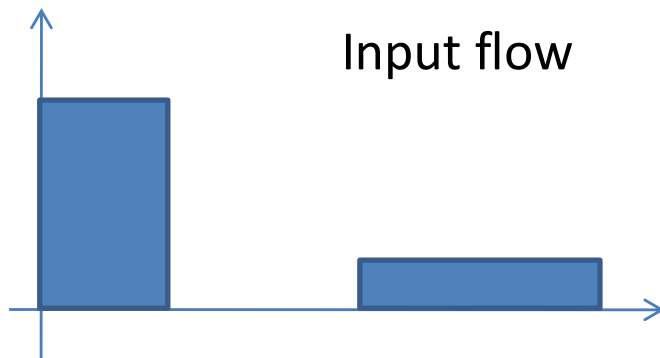

## *Token bucket*

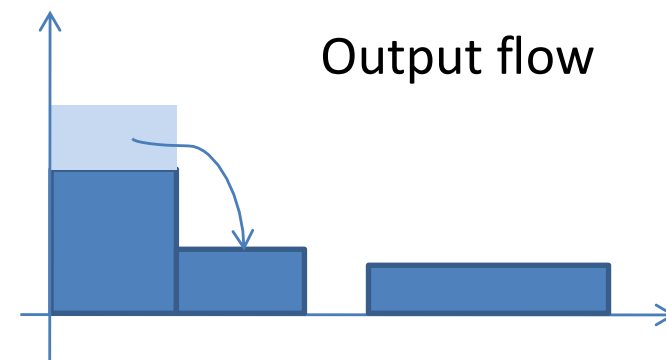
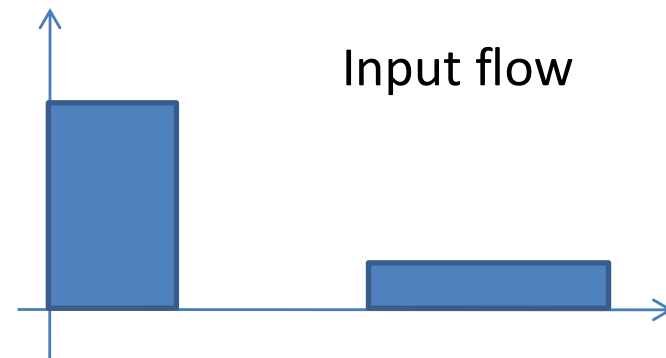



# Traffic shaping: *Leaky bucket*

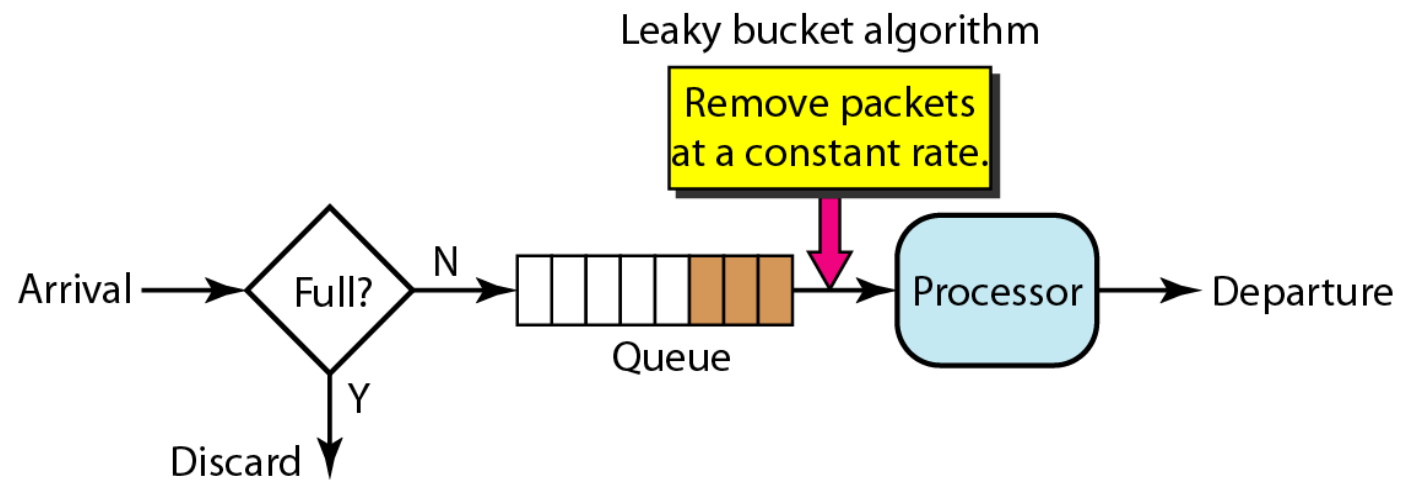
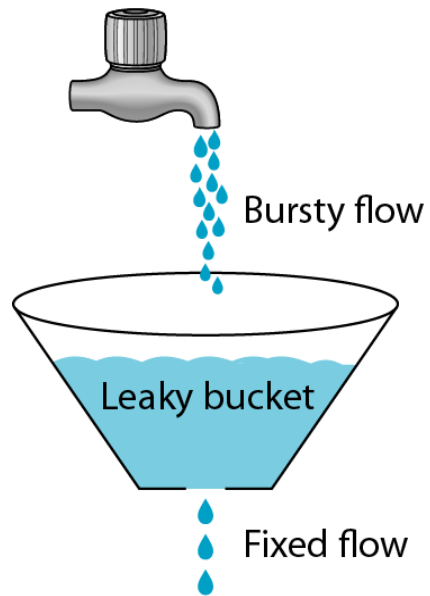

See also Figure 20.7

# Traffic shaping: *Token bucket*

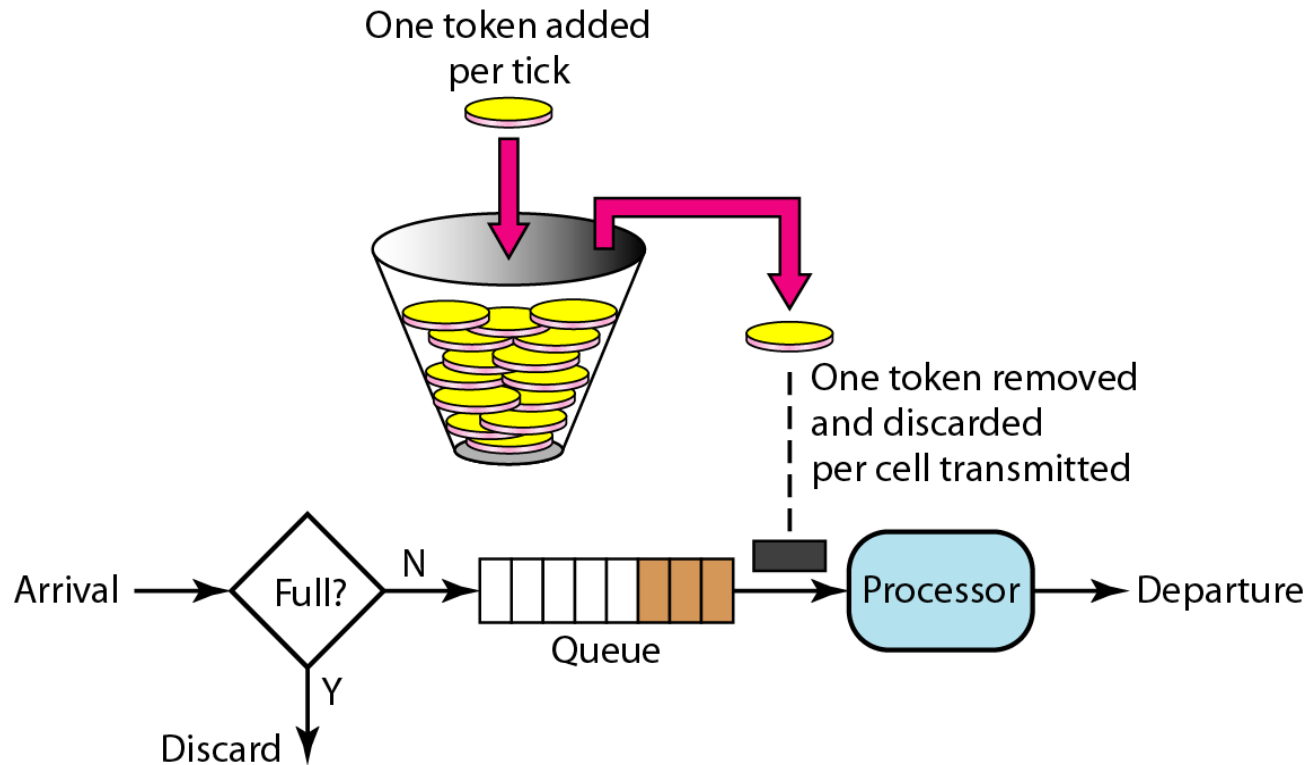

See also Figure 20.6

# Token Bucket

- Widely used traffic management tool
- Advantages:
  - Many traffic sources can be defined easily and accurately
  - Provides a concise description of the load to be imposed by a flow, enabling the service to determine easily the resource requirement
  - Provides the input parameters to a policing function



# Bonus: QoE, Quality of Experience

- The user's subjective perception of the presentation of the content
- Mean Opinion Score (MOS)
- Research for to find objective measures
  - Full reference
  - No reference
  - Hybrid
- What QoS give what QoE??

<https://goo.gl/forms/IRcUYcJCZTu8uo152>

