



Lecture no: **6**

## Demodulation, bit-error probability and diversity arrangements

Ove Edfors, Department of Electrical and Information Technology  
Ove.Edfors@eit.lth.se

# Contents



- Receiver noise calculations [**Covered briefly in Chapter 3 of textbook!**]
- Optimal receiver and bit error probability
  - Principle of maximum-likelihood receiver
  - Error probabilities in non-fading channels
  - Error probabilities in fading channels
- Diversity arrangements
  - The diversity principle
  - Types of diversity
  - Spatial (antenna) diversity performance



# RECEIVER NOISE

# Receiver noise

## Noise sources



The noise situation in a receiver depends on several noise sources

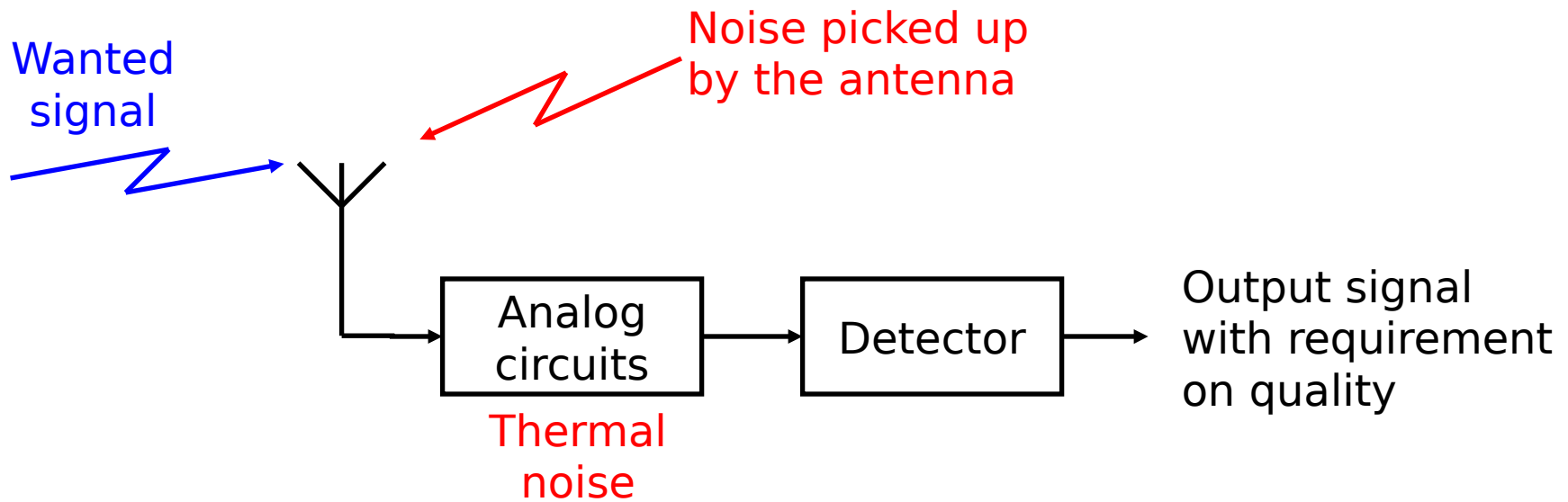



# Receiver noise

## Equivalent noise source

To simplify the situation, we replace all noise sources with a single equivalent noise source.

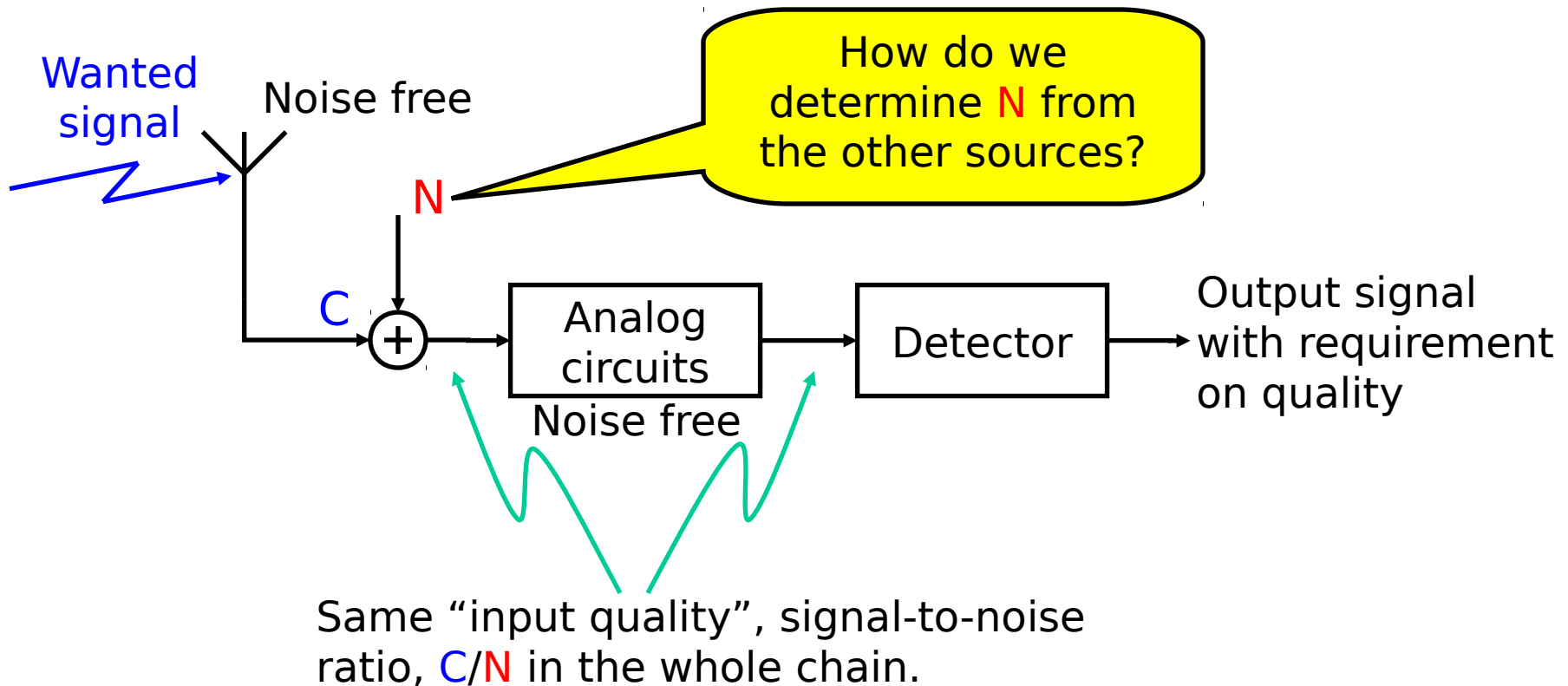



# Receiver noise

## Examples

- **Thermal noise** is caused by random movements of electrons in circuits. It is assumed to be Gaussian and the power is proportional to the temperature of the material, in Kelvin.
- **Atmospheric noise** is caused by electrical activity in the atmosphere, e.g. lightning. This noise is impulsive in its nature and below 20 MHz it is a dominating.
- **Cosmic noise** is caused by radiation from space and the sun is a major contributor.
- **Artificial (man made) noise** can be very strong and, e.g., light switches and ignition systems can produce significant noise well above 100 MHz.



# Receiver noise

## Noise sources

The power spectral density of a noise source is usually given in one of the following three ways:

1) Directly [W/Hz]:

 $N_s$ 

2) Noise **temperature** [Kelvin]:

 $T_s$ 

3) Noise **factor** [1]:

 $F_s$ 

This one is often given in dB and called **noise figure**.

The relation between the three is

$$N_s = kT_s = kF_sT_0$$

where  $k$  is **Boltzmann's constant** ( $1.38 \times 10^{-23}$  W/Hz) and  $T_0$  is the, so called, **room temperature** of 290 K (17° C).

# Receiver noise

## Noise sources, cont.

### Antenna example

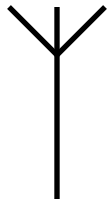

Noise temperature  
of antenna 1600 K

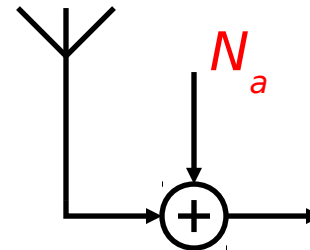
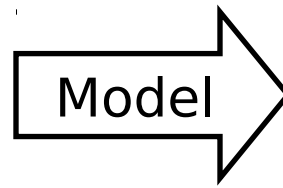

Noise free  
antenna

Power spectral density of antenna noise is

$$N_a = 1.38 \times 10^{-23} \times 1600 = 2.21 \times 10^{-20} \text{ W/Hz} = -196.6 \text{ dB [W/Hz]}$$

and its noise factor/noise figure is

$$F_a = 1600/290 = 5.52 = 7.42 \text{ dB}$$



# Receiver noise

## System noise



The noise factor or noise figure of a system component (with input and output) is defined in a different way than for noise sources:

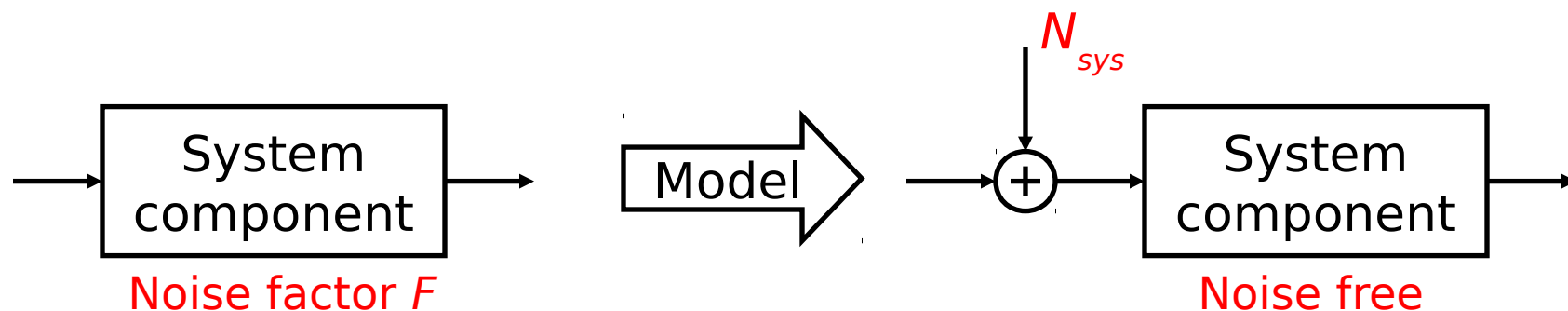

Due to a definition of noise factor (in this case) as the ratio of noise powers on the output versus on the input, when a resistor in room temperature ( $T_0=290$  K) generates the input noise, the PSD of the equivalent noise source (placed **at the input**) becomes

$$N_{sys} = k \underbrace{(F - 1)}_{\text{Equivalent noise temperature}} T_0 \text{ W/Hz}$$

Don't use dB value!

Equivalent noise temperature

# Receiver noise

## Several noise sources



### A simple example

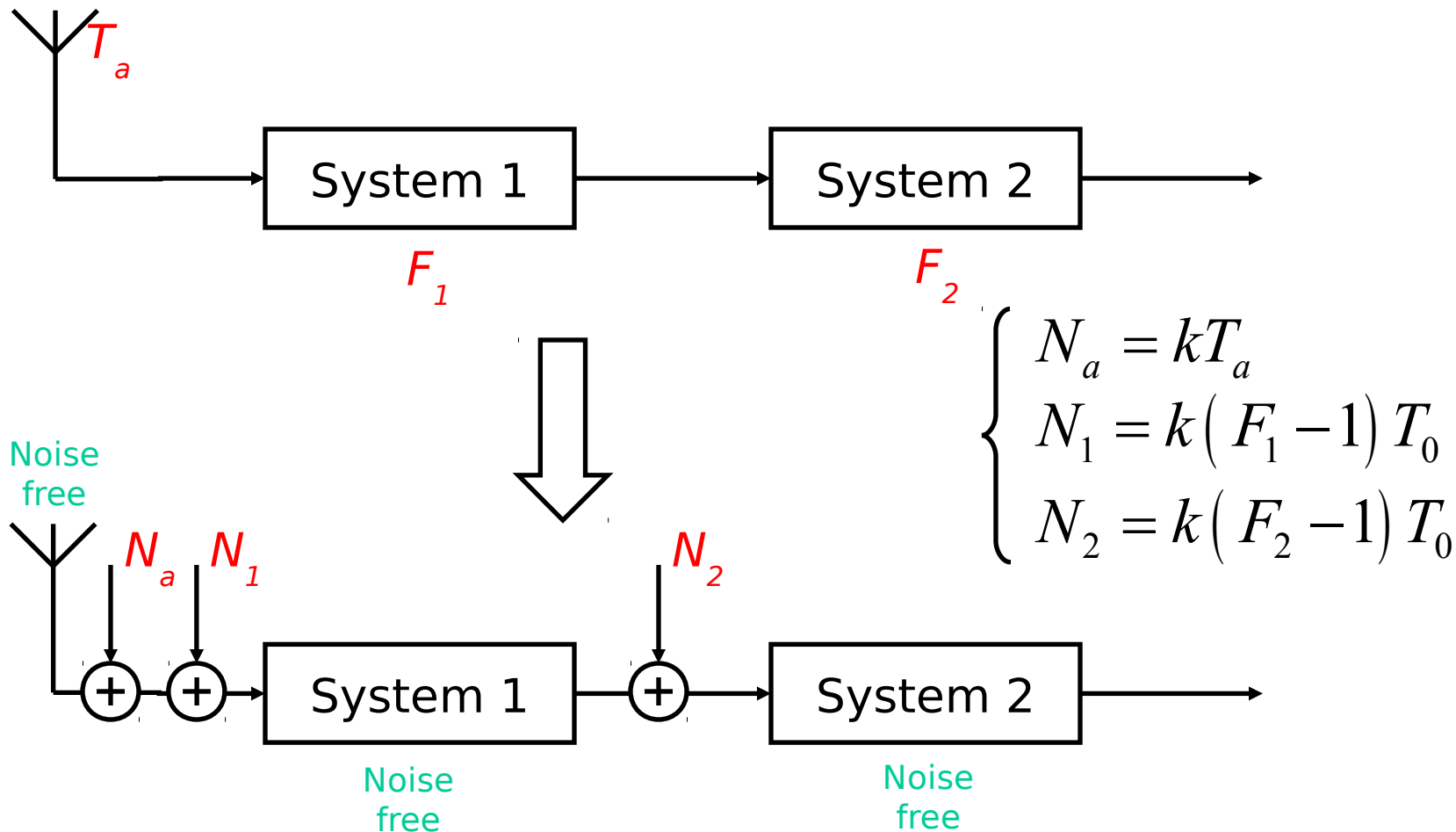



# Receiver noise

## Several noise sources, cont.

After extraction of the noise sources from each component, we need to move them to one point.

When doing this, we must compensate for amplification and attenuation!

*Amplifier:*

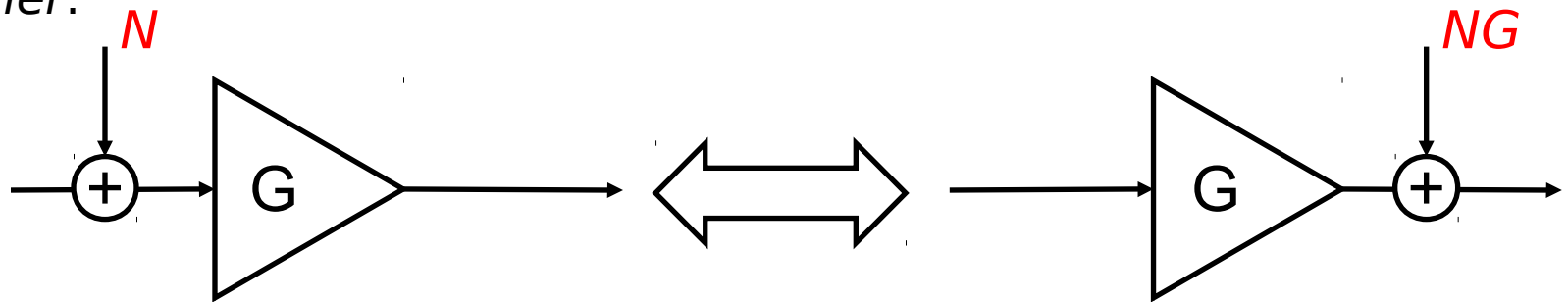

*Attenuator:*

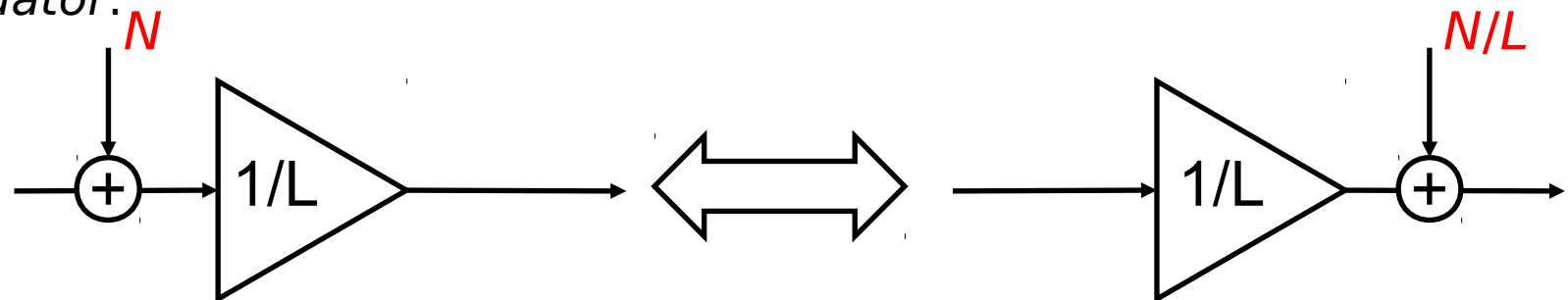



# Receiver noise

## Pierce's rule

A passive attenuator in room temperature, in this case a feeder, has a noise figure equal to its attenuation.

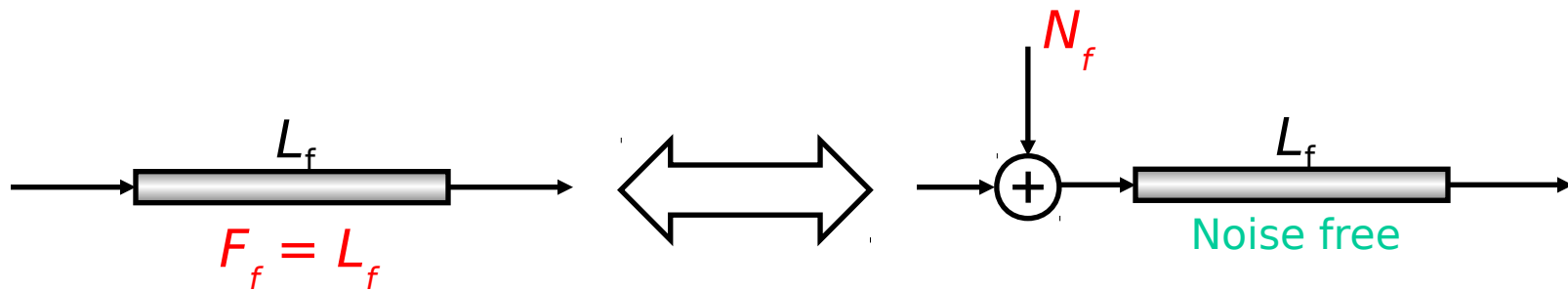

$$N_f = k(F_f - 1)T_0 = k(L_f - 1)T_0$$

Remember to  
convert **from** dB!

# Receiver noise

## Remember ...



Antenna noise is usually given as a noise temperature!

Noise factors or noise figures of different system components are determined by their implementation.

When adding noise from several sources, remember to convert **from** the dB-scale noise figures that are usually given, before starting your calculations.

A passive attenuator in (room temperature), like a feeder, has a noise figure/factor equal to its attenuation.

# Receiver noise

## A final example



Let's consider two (incomplete) receiver chains with **equal gain** from point A to B:

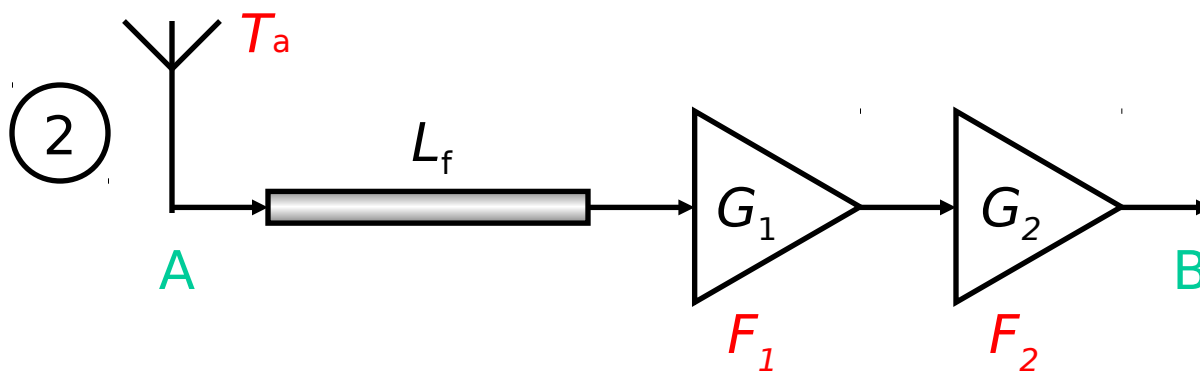
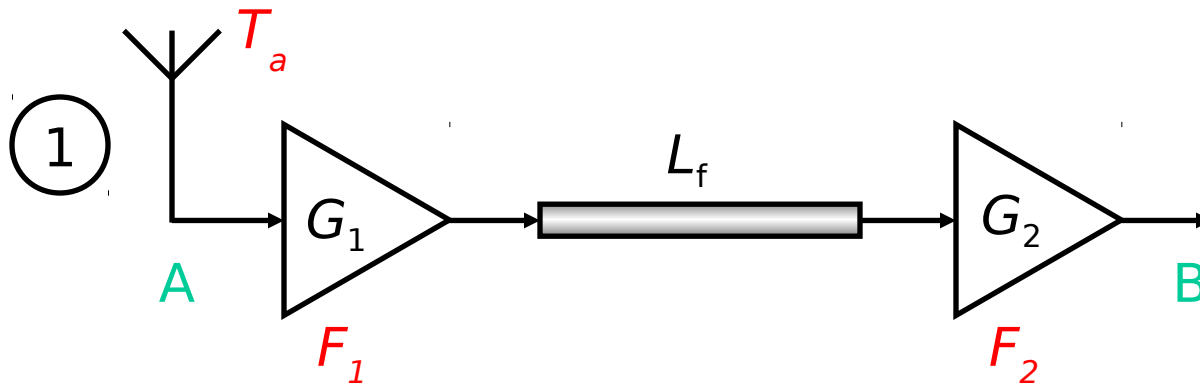

Would there be any reason to choose one over the other?

Let's calculate the equivalent noise at point **A** for both!

# Receiver noise

## A final example

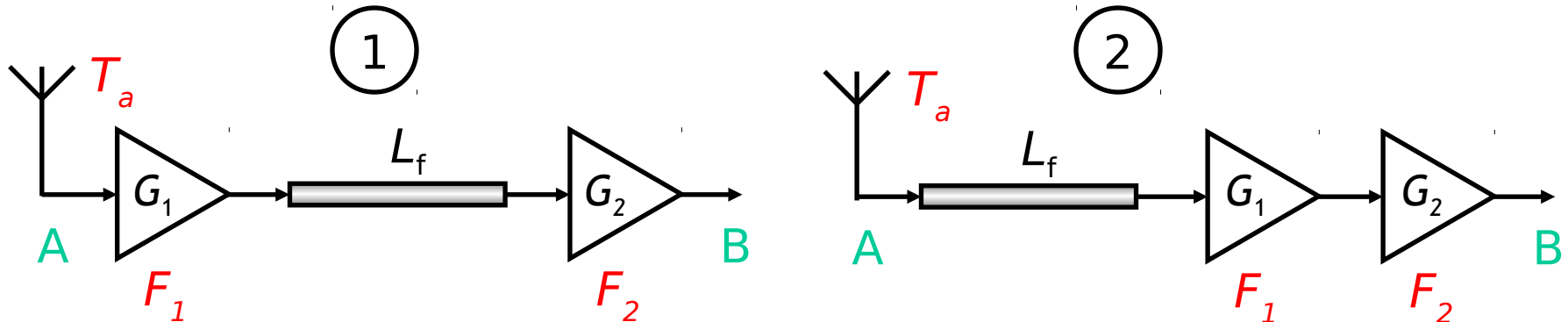

Equivalent noise sources at point A for the two cases would have the power spectral densities:

$$\textcircled{1} \quad N_0 = kT_a + k \left( \underbrace{(F_1 - 1)}_{\text{green}} + \underbrace{(L_f - 1) / G_1}_{\text{red}} + \underbrace{(F_2 - 1) L_f / G_1}_{\text{green}} \right) T_0$$

$$\textcircled{2} \quad N_0 = kT_a + k \left( \underbrace{(L_f - 1)}_{\text{red}} + \underbrace{(F_1 - 1) L_f}_{\text{red}} + \underbrace{(F_2 - 1) L_f / G_1}_{\text{green}} \right) T_0$$

Two of the noise contributions are **equal** and two are **larger** in (2), which makes (1) a better arrangement.

This is why we want a low-noise amplifier (LNA) close to the antenna.

# Receiver noise

## Noise power



We have discussed noise in terms of *power spectral density*  $N_0$  [W/Hz].

For a certain receiver bandwidth  $B$  [Hz], we can calculate the equivalent *noise power*:

$$N = B \times N_0 \text{ [W]}$$

$$N_{\text{dB}} = B_{\text{dB}} + N_{0\text{dB}} \text{ [dBW]}$$

This is the version we will use in our link budget.



# Receiver noise

## The link budget

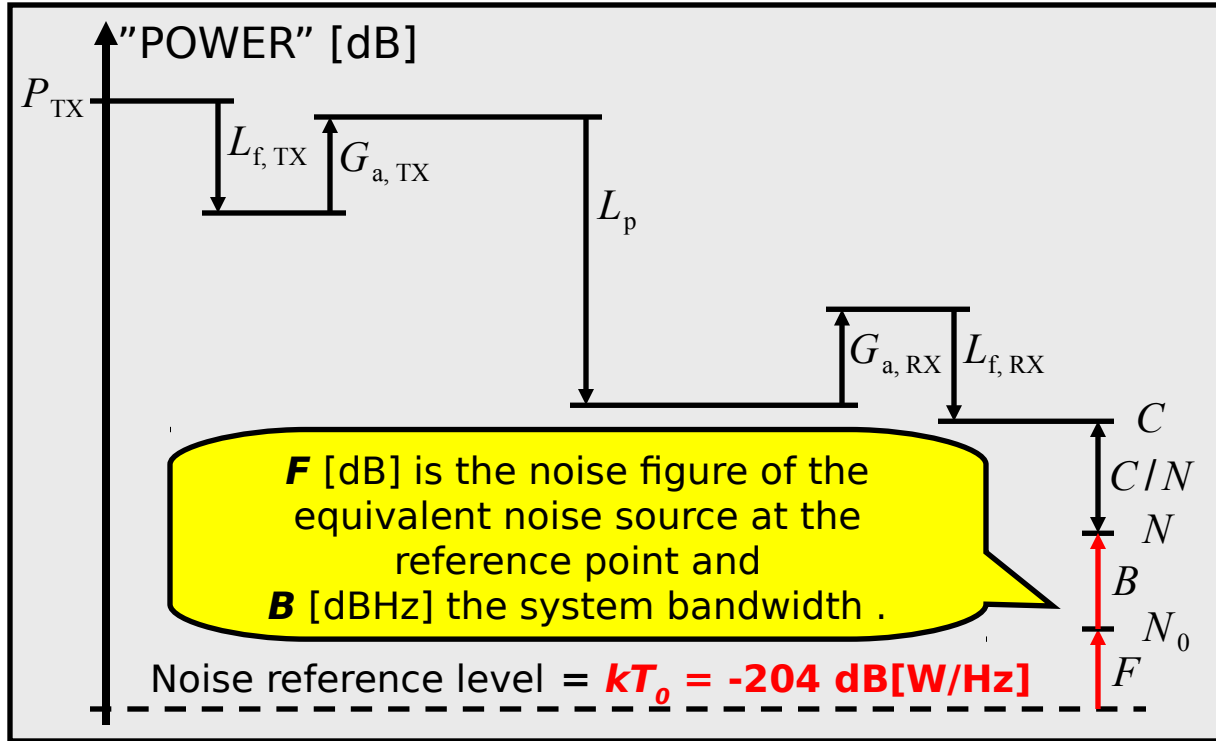

The receiver noise calculations show up here.

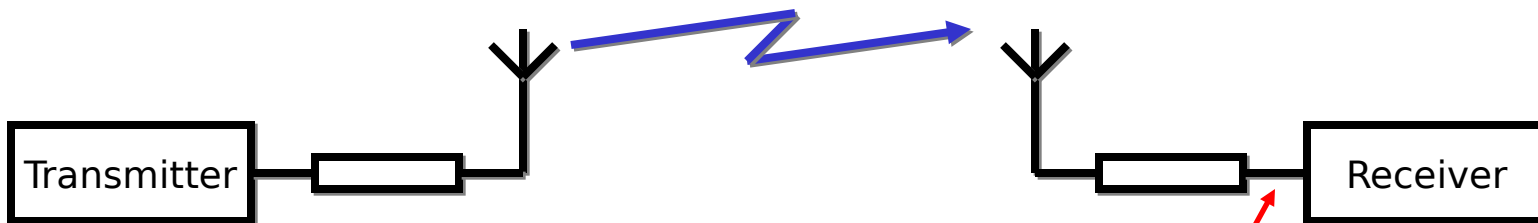

In this version the reference point is here



# OPTIMAL RECEIVER AND BIT ERROR PROBABILITY

# Optimal receiver

## What do we mean by optimal?



Every receiver is optimal according to some criterion!

We would like to use optimal in the sense that we achieve a minimal probability of error.

In all calculations, we will assume that the noise is white and Gaussian - unless otherwise stated.

# Optimal receiver

## Transmitted and received signal



Transmitted signals

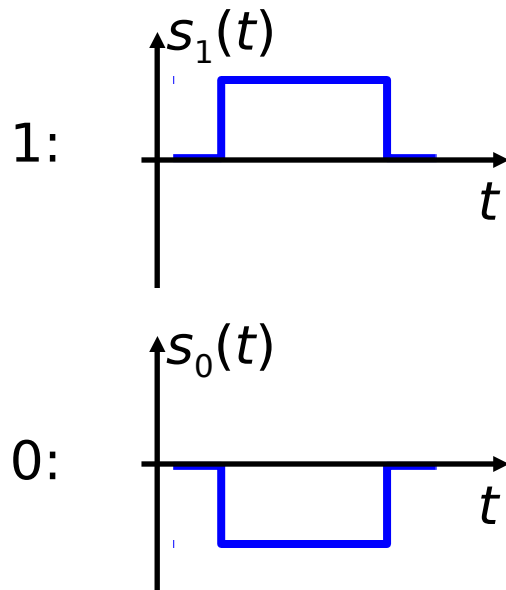

Channel

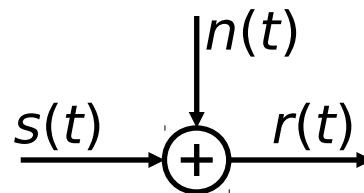

Received (noisy) signals

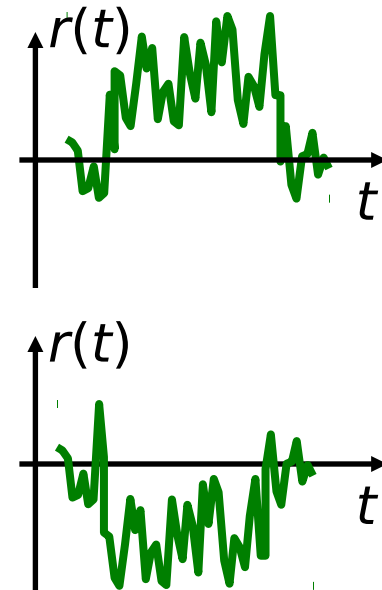



# Optimal receiver

## A first “intuitive” approach

“Look” at the received signal and compare it to the possible received **noise free** signals. Select the one with the best “fit”.

Assume that the following signal is received:

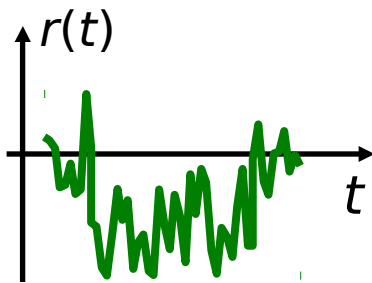

Comparing it to the two possible **noise free** received signals:

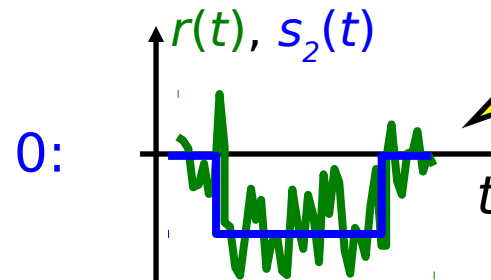
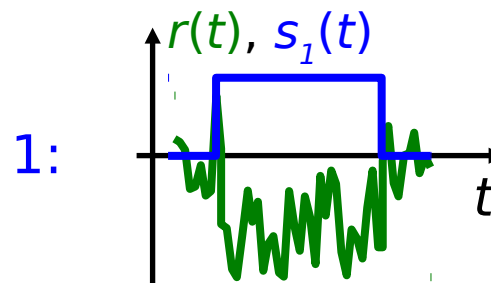

This seems to be the best “fit”. We assume that “0” was the transmitted bit.

# Optimal receiver

## Let's make it more measurable



To be able to better measure the “fit” we look at the **energy** of the **residual** (difference) between received and the possible noise free signals:

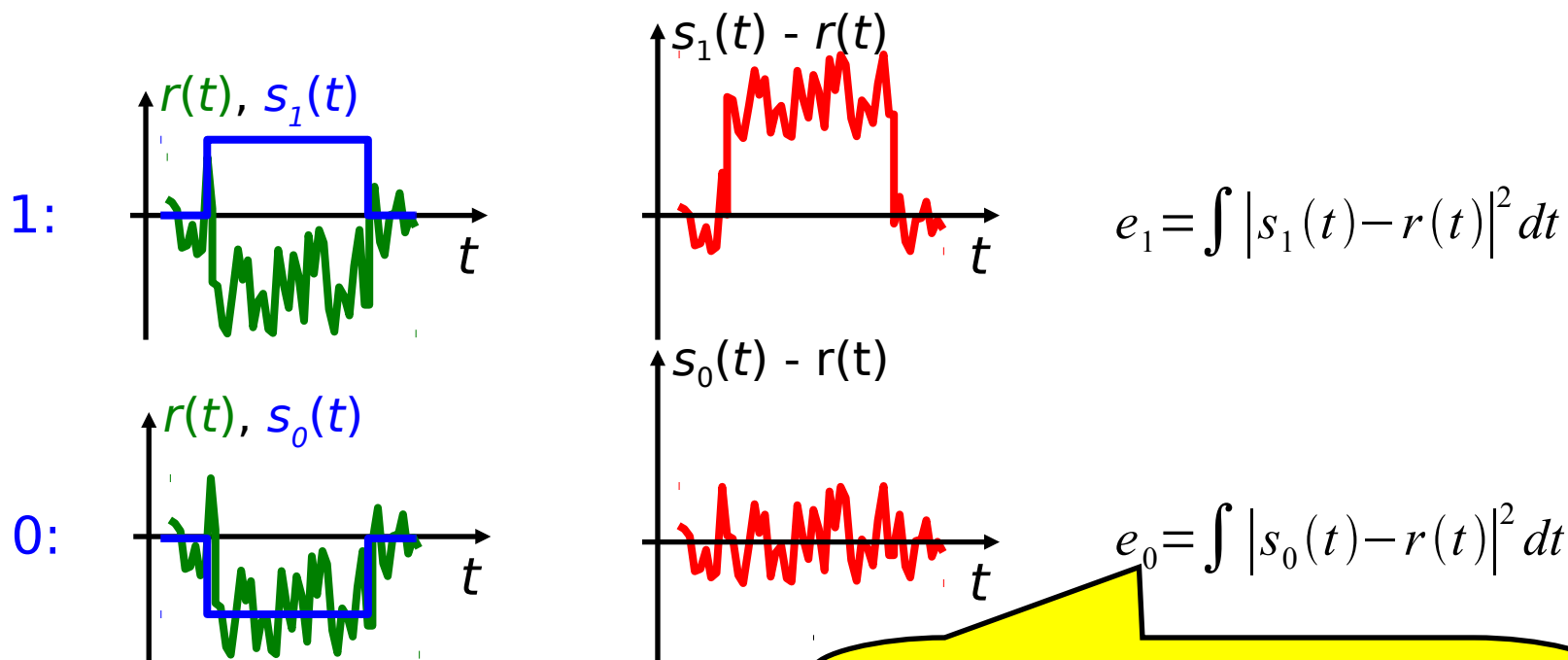

This residual energy is much smaller. We assume that “0” was transmitted.

# Optimal receiver

## The AWGN channel



The additive white Gaussian noise (AWGN) channel

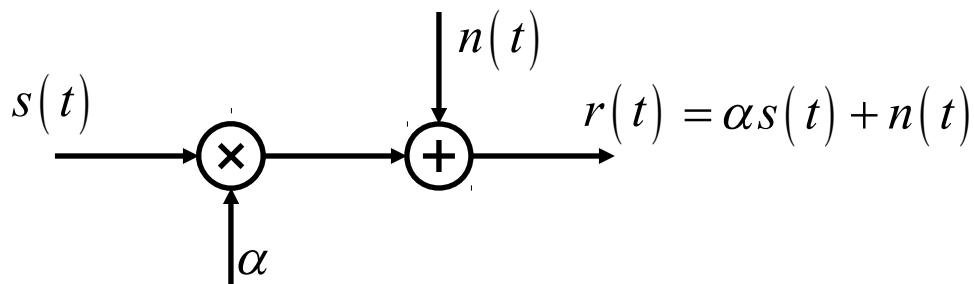

- $s(t)$  - transmitted signal
- $\alpha$  - channel attenuation
- $n(t)$  - white Gaussian noise
- $r(t)$  - received signal

In our digital transmission system, the transmitted signal  $s(t)$  would be one of, let's say  $M$ , different alternatives  $s_0(t), s_1(t), \dots, s_{M-1}(t)$ .

# Optimal receiver

## The AWGN channel, cont.



It can be shown that finding the minimal residual energy (as we did before) is the optimal way of deciding which of  $s_0(t)$ ,  $s_1(t)$ , ...,  $s_{M-1}(t)$  was transmitted over the AWGN channel (if they are equally probable).

For a received  $r(t)$ , the residual energy  $e_i$  for each possible transmitted alternative  $s_i(t)$  is calculated as

$$e_i = \int |r(t) - \alpha s_i(t)|^2 dt = \int (r(t) - \alpha s_i(t))(r(t) - \alpha s_i(t))^* dt$$
$$= \int |r(t)|^2 dt - 2 \operatorname{Re} \left\{ \alpha^* \int r(t) s_i^*(t) dt \right\} + |\alpha|^2 \int |s_i(t)|^2 dt$$

Same for all  $i$

Same for all  $i$ ,  
if the transmitted  
signals are of  
equal energy.

The residual energy is minimized by **maximizing** this part of the expression.



# Optimal receiver

## The AWGN channel, cont.



The central part of the comparison of different signal alternatives is a correlation, that can be implemented as a correlator:

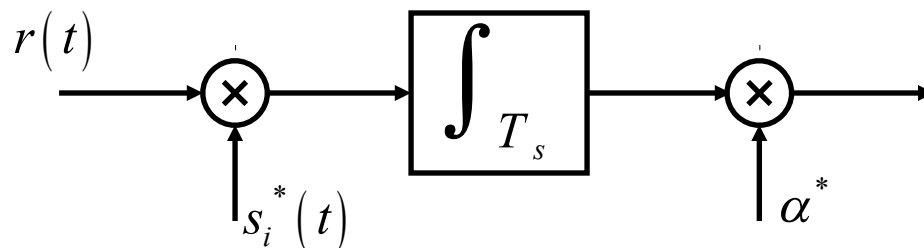

or a matched filter

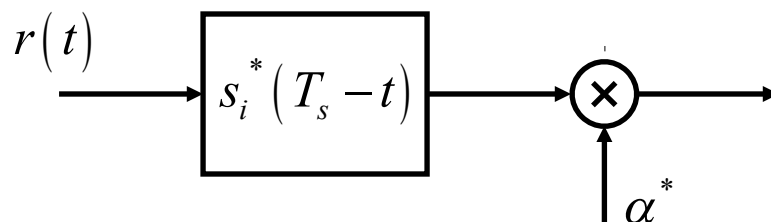

where  $T_s$  is the symbol time (duration).

The real part of the output from either of these is sampled at  $t = T_s$

# Optimal receiver Antipodal signals



In antipodal signaling, the alternatives (for “0” and “1”) are

$$s_0(t) = \varphi(t)$$

$$s_1(t) = -\varphi(t)$$

This means that we only need ONE correlation in the receiver for simplicity:

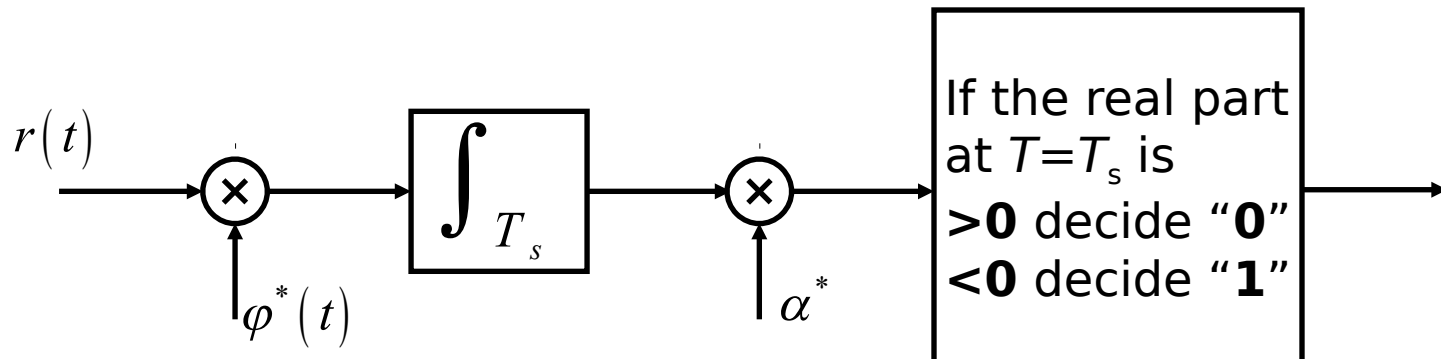

# Optimal receiver Orthogonal signals



In binary orthogonal signaling, with equal energy alternatives  $s_0(t)$  and  $s_1(t)$  (for “0” and “1”) we require the property:

$$\langle s_0(t), s_1(t) \rangle = \int s_0(t) s_1^*(t) dt = 0$$

The approach here is to use two correlators:

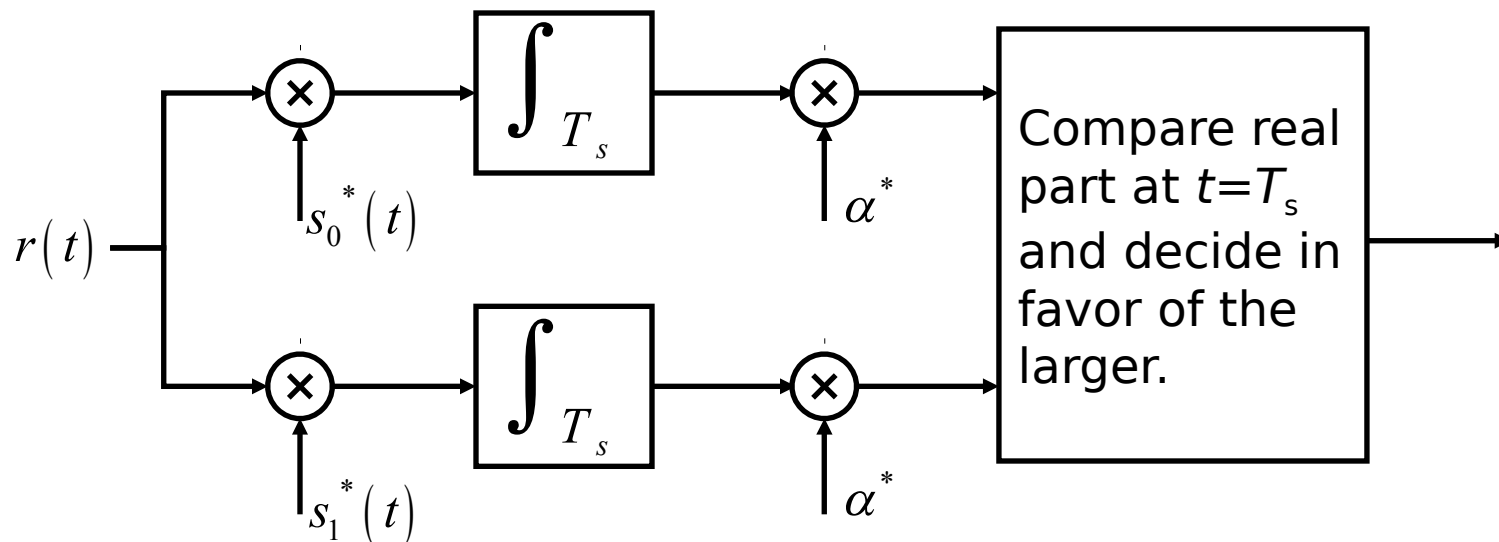

(Only one correlator is needed, if we correlate with  $(s_0(t) - s_1(t))^*$ .)



# Optimal receiver

## Interpretation in signal space

The correlations performed on the previous slides can be seen as inner products between the received signal and a set of basis functions for a signal space.

The resulting values are coordinates of the received signal in the signal space.

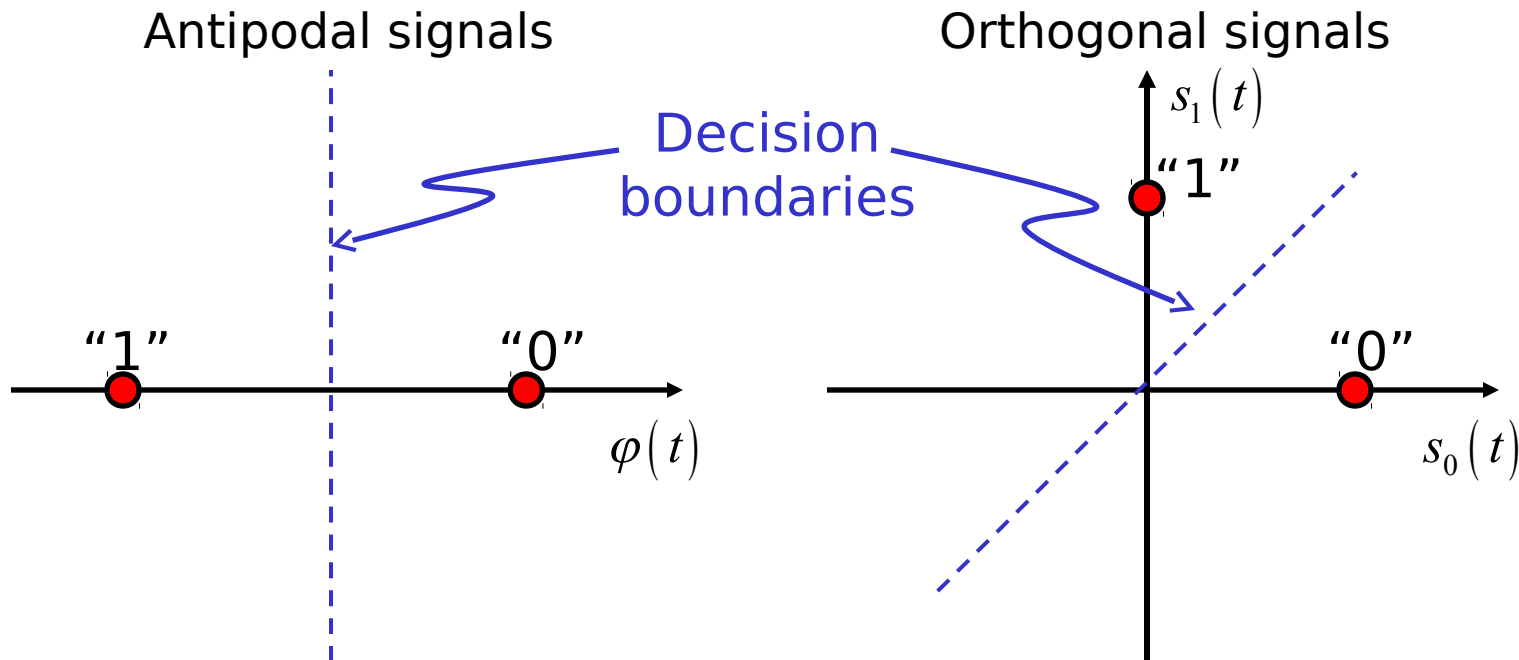



# Optimal receiver

## The noise contribution

Assume a 2-dimensional signal space, here viewed as the complex plane

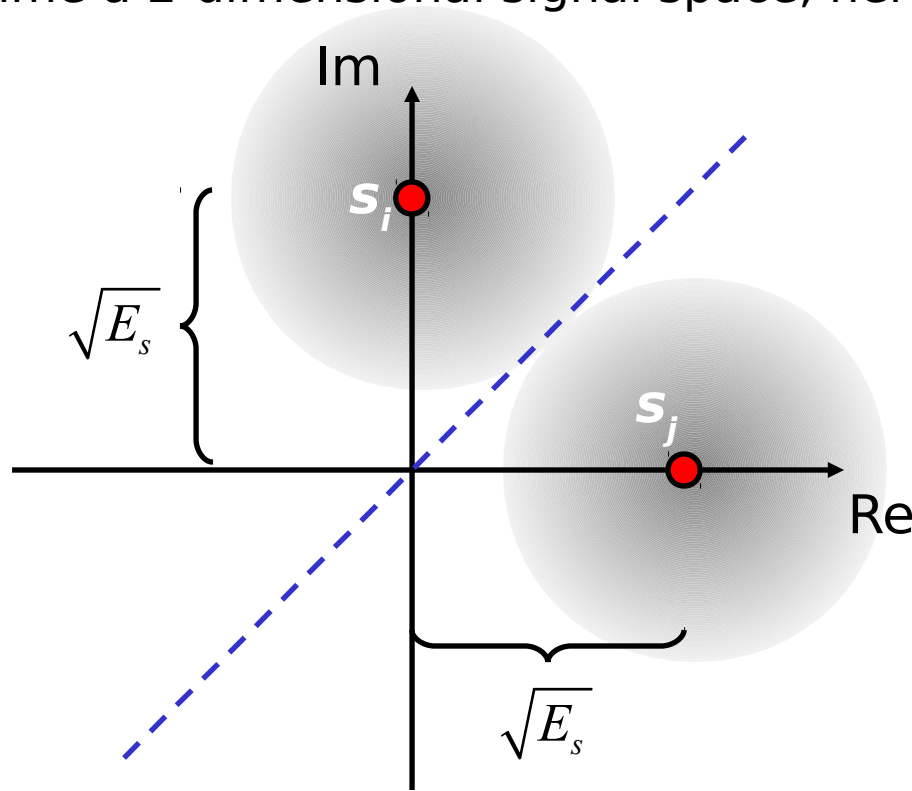

- Noise-free positions
- Noise pdf.

This normalization of axes implies that the noise centered around each alternative is complex Gaussian

$$\mathcal{N}(0, \sigma^2) + j\mathcal{N}(0, \sigma^2)$$

with variance  $\sigma^2 = N_0/2$  in each direction.

**Fundamental question:** What is the probability that we end up on the wrong side of the decision boundary?



# Optimal receiver

## Pair-wise symbol error probability

What is the probability of deciding  $s_i$  if  $s_j$  was transmitted?

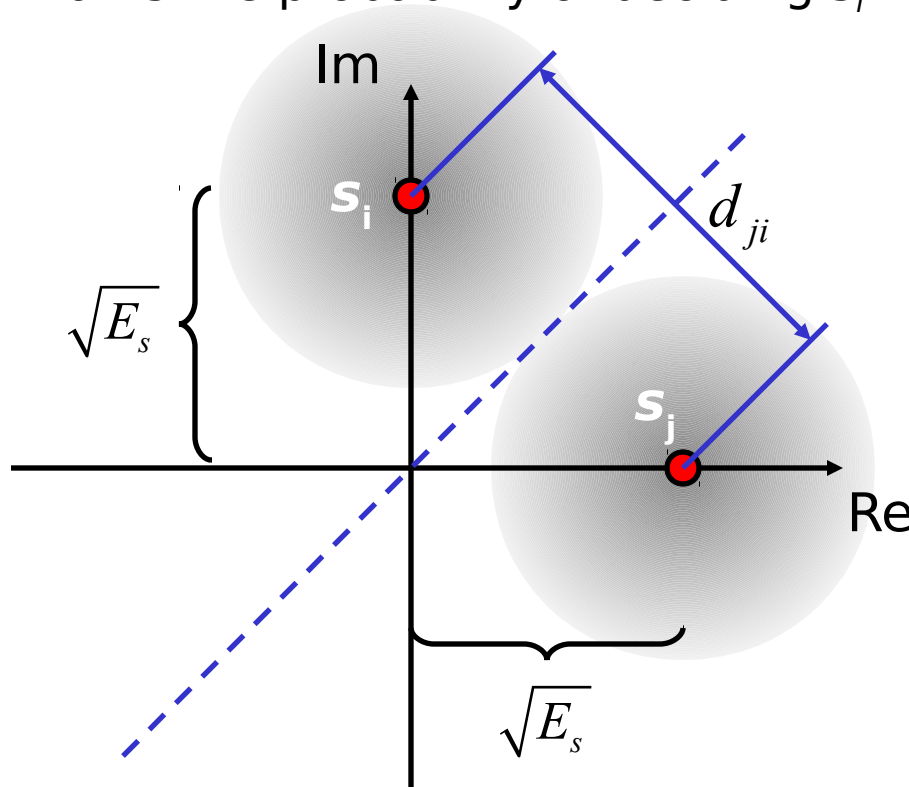

We need the distance between the two symbols. In this orthogonal case:

$$d_{ji} = \sqrt{\sqrt{E_s}^2 + \sqrt{E_s}^2} = \sqrt{2E_s}$$

The probability of the noise pushing us across the boundary at distance  $d_{ji}/2$  is

$$\begin{aligned} \Pr(s_j \rightarrow s_i) &= Q\left(\frac{d_{ji}/2}{\sqrt{N_0}/2}\right) = Q\left(\sqrt{\frac{E_s}{N_0}}\right) \\ &= \frac{1}{2} \operatorname{erfc}\left(\sqrt{\frac{E_s}{2N_0}}\right) \end{aligned}$$

The book uses **erfc()** instead of **Q()**.

# Optimal receiver

## The union bound

Calculation of symbol error probability is simple for two signals!

When we have many signal alternatives, it may be impossible to calculate an exact symbol error rate.

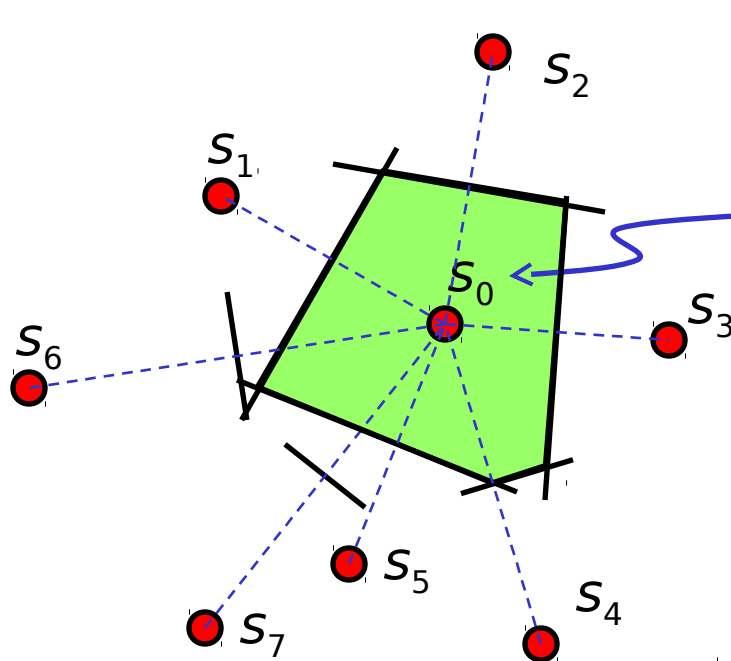

When  $s_0$  is the transmitted signal, an error occurs when the received signal is outside this polygon.

The UNION BOUND is the **sum of all pair-wise error probabilities**, and constitutes an upper bound on the symbol error probability.

The higher the SNR, the better the approximation!

# Optimal receiver

## Symbol- and bit-error rates



The calculations so far have discussed the probabilities of selecting the incorrect signal alternative (symbol), i.e. the symbol-error rate.

When each symbol carries  $K$  bits, we need  $2^K$  symbols.

**Gray coding** is used to assigning bits so that the nearest neighbors only differ in one of the  $K$  bits. This minimizes the bit-error rate.

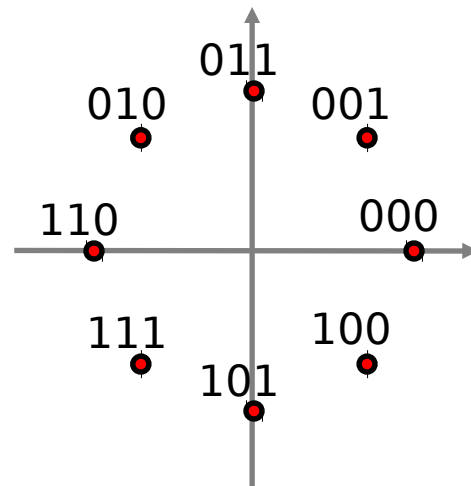

Gray-coded 8PSK



# Optimal receiver

## Bit-error rates (BER)



### EXAMPLES:

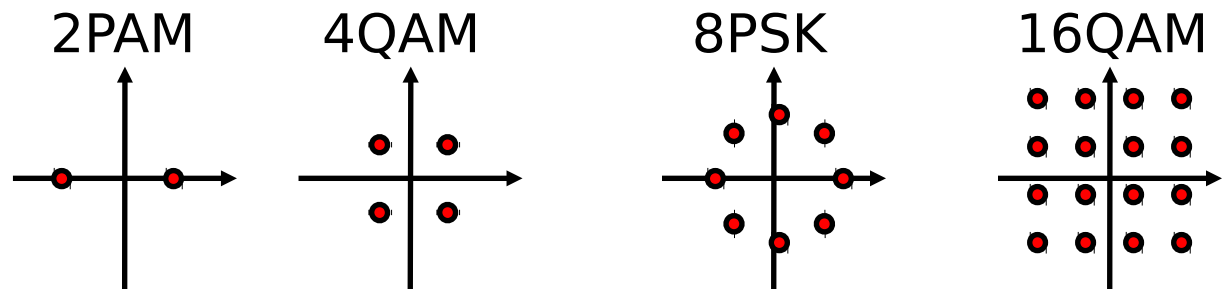

Bits/symbol

1

2

3

4

Symbol energy

$E_b$

$2E_b$

$3E_b$

$4E_b$

BER

$$Q\left(\sqrt{\frac{2E_b}{N_0}}\right)$$

$$Q\left(\sqrt{\frac{2E_b}{N_0}}\right)$$

$$\sim \frac{2}{3} Q\left(\sqrt{0.87 \frac{E_b}{N_0}}\right)$$

$$\sim \frac{3}{2} Q\left(\sqrt{\frac{E_{b, \max}}{2.25 N_0}}\right)$$

Gray coding is used when calculating these BER.

# Optimal receiver

## Bit-error rates (BER), cont.

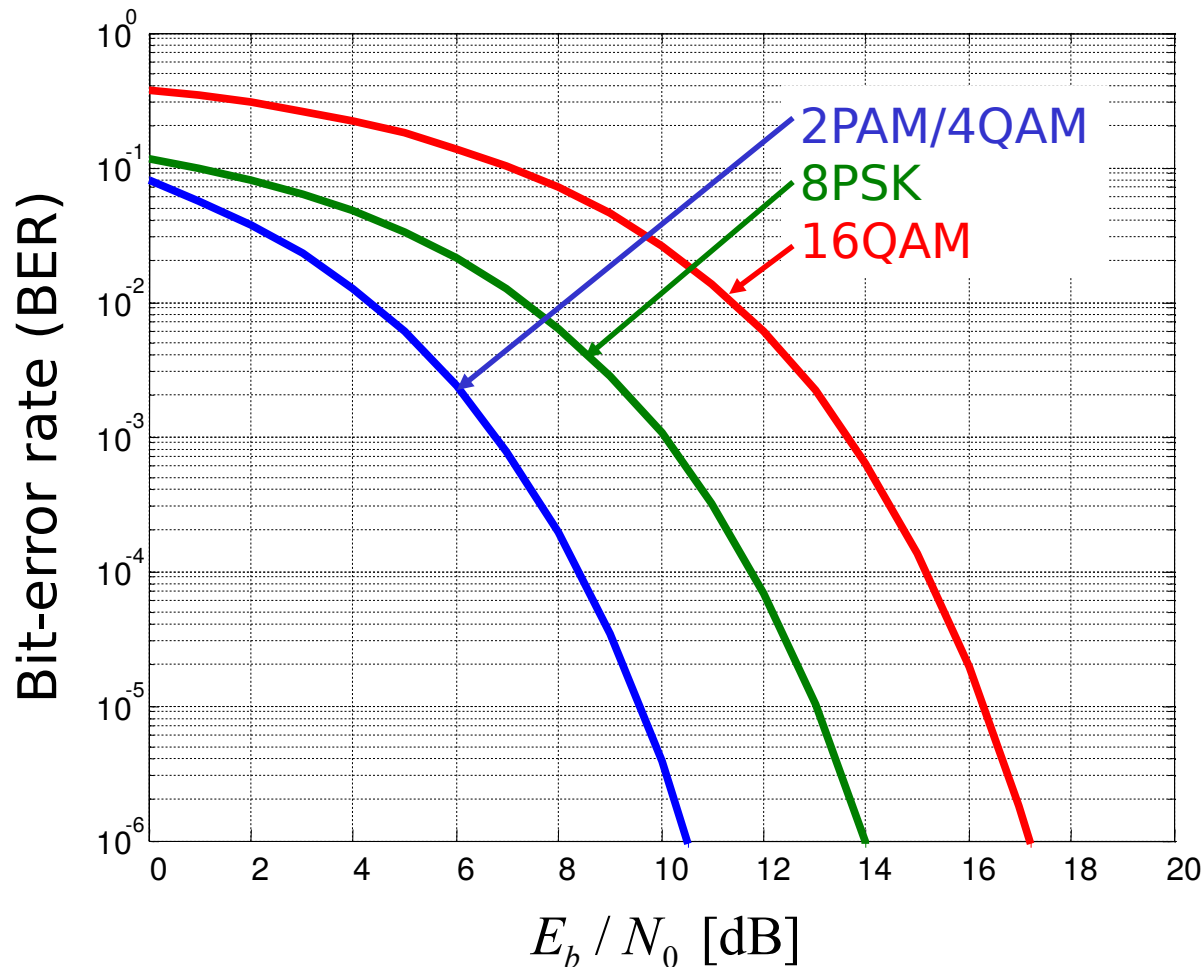

# Optimal receiver

## Where do we get $E_b$ and $N_0$ ?



Where do those magic numbers  $E_b$  and  $N_0$  come from?

The noise power spectral density  $N_0$  is calculated according to

$$N_0 = k T_0 F_0 \Leftrightarrow N_{0|\text{dB}} = -204 + F_{0|\text{dB}}$$

where  $F_0$  is the noise factor of the “equivalent” receiver noise source.

The bit energy  $E_b$  can be calculated from the received power  $C$  (at the **same** reference point as  $N_0$ ). Given a certain data-rate  $d_b$  [bits per second], we have the relation

$$E_b = C / d_b \Leftrightarrow E_{b|\text{dB}} = C_{|\text{dB}} - d_{b|\text{dB}}$$

THESE ARE THE EQUATIONS THAT RELATE DETECTOR PERFORMANCE ANALYSIS TO LINK BUDGET CALCULATIONS!



# Optimal receiver

## What about fading channels?

We have (or can calculate) BER expressions for non-fading AWGN channels.

If the channel is Rayleigh-fading, then  $E_b/N_0$  will have an exponential distribution ( $N_0$  is assumed to be constant)

$$pdf(\gamma_b) = \frac{1}{\bar{\gamma}_b} e^{-\gamma_b/\bar{\gamma}_b}$$

$\gamma_b$	-- $E_b/N_0$
$\bar{\gamma}_b$	-- average $E_b/N_0$

The BER for the Rayleigh fading channel is obtained by averaging:

$$BER_{\text{Rayleigh}}(\bar{\gamma}_b) = \int_0^{\infty} BER_{\text{AWGN}}(\gamma_b) \times pdf(\gamma_b) d\gamma_b$$

# Optimal receiver

## What about fading channels?



THIS IS A SERIOUS PROBLEM!

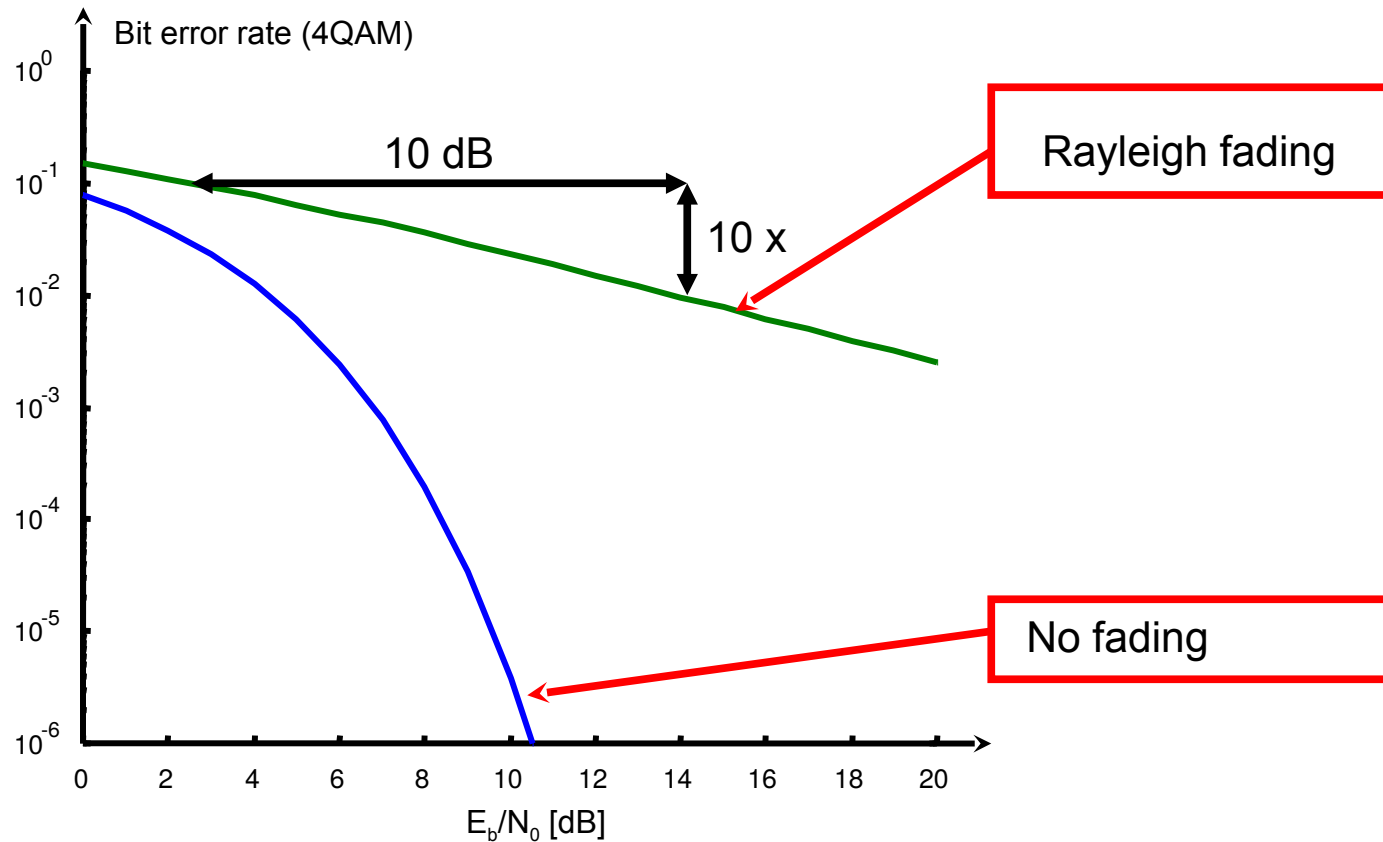



# DIVERSITY ARRANGEMENTS

# Diversity arrangements

## Let's have a look at fading again

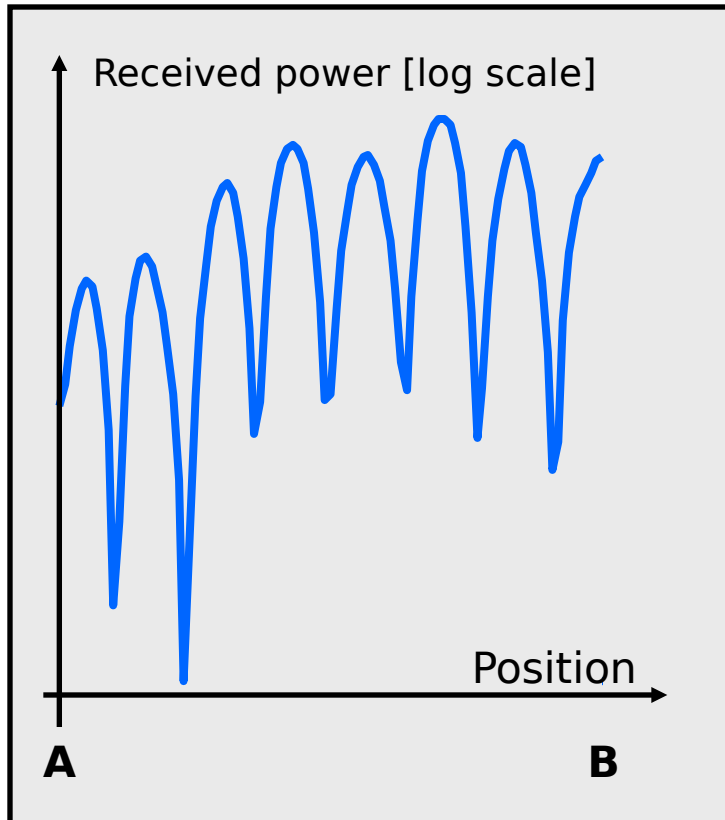
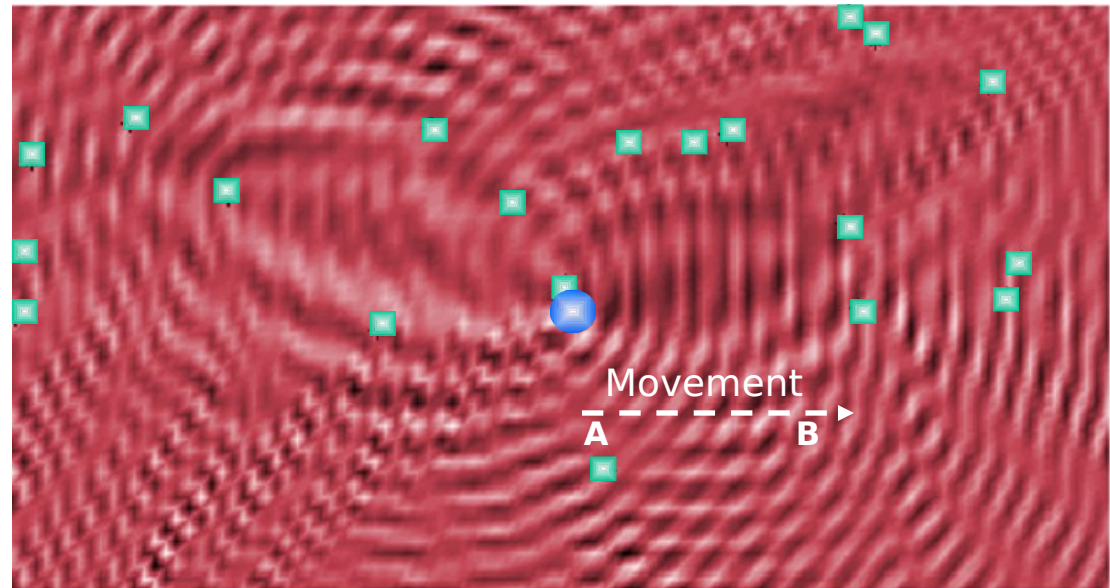

Illustration of interference pattern from above



- Transmitter
- Reflector

Having TWO separated antennas in this case may increase the probability of receiving a strong signal on at least one of them.

# Diversity arrangements

## The diversity principle



The principle of diversity is to transmit the same information on  $M$  statistically independent channels.

By doing this, we increase the chance that the information will be received properly.

The example given on the previous slide is one such arrangement: antenna diversity.



# Diversity arrangements

## General improvement trend

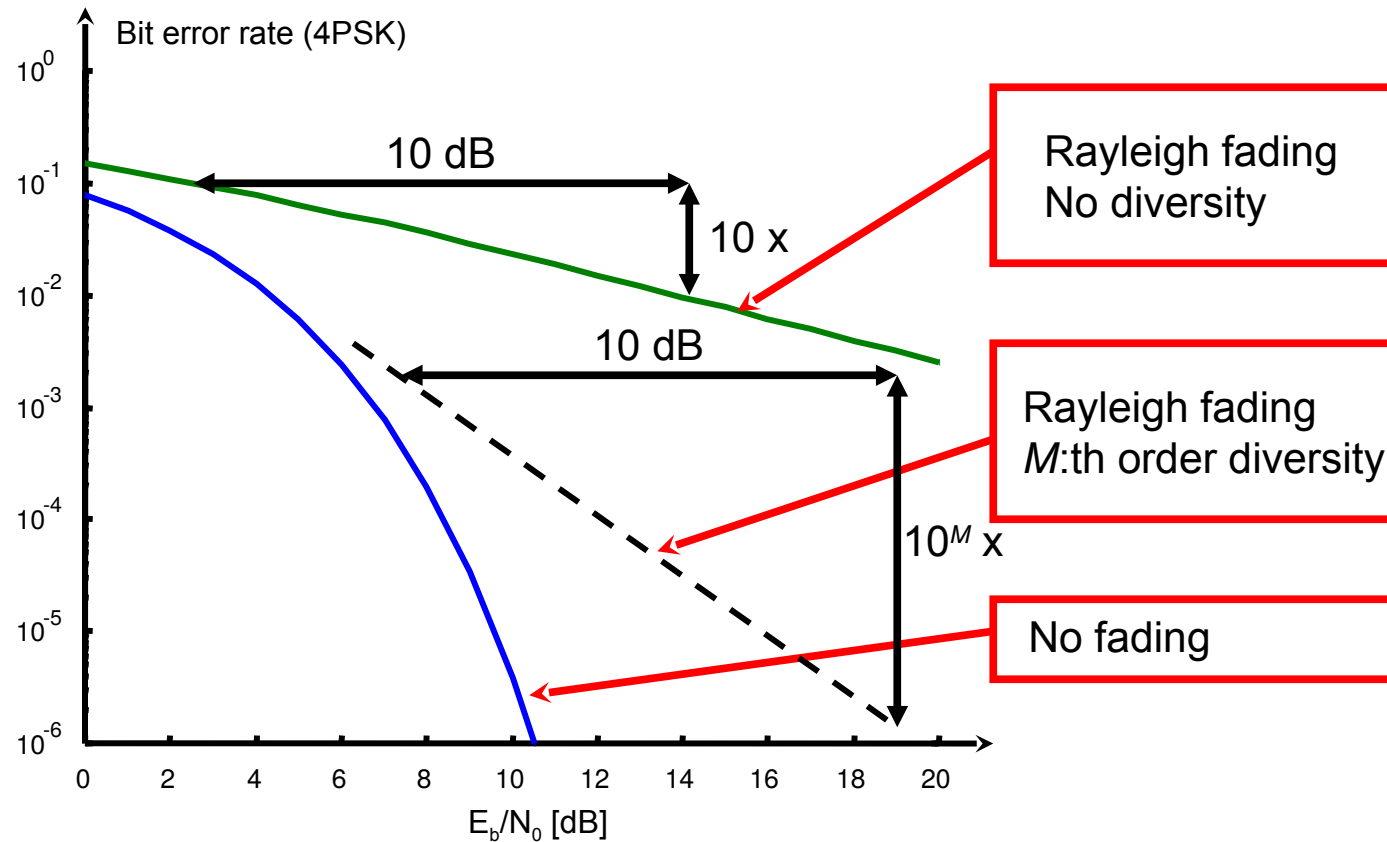

# Diversity arrangements

## Some techniques



### Spatial (antenna) diversity

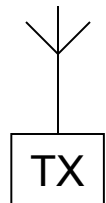

We will focus on this one today!

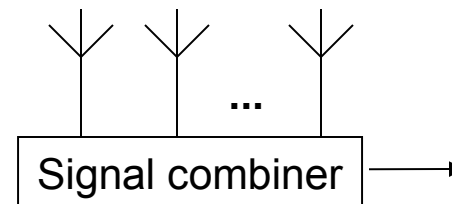

### Frequency diversity

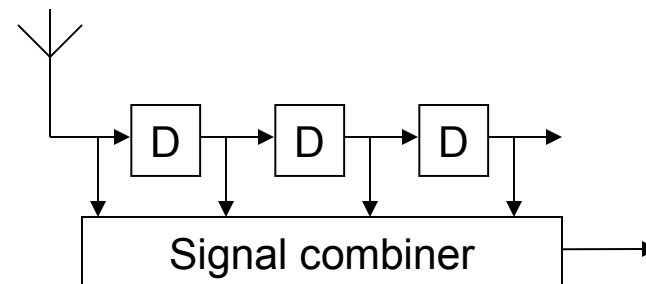
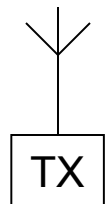

### Temporal diversity

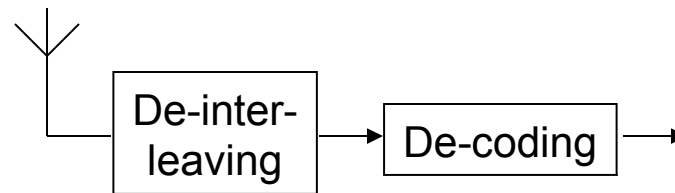
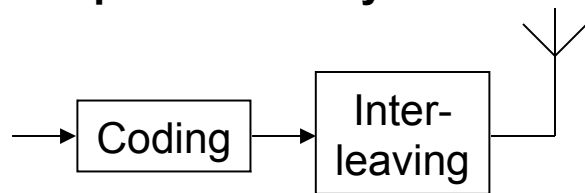

(We also have angular and polarization diversity)

# Spatial (antenna) diversity

## Fading correlation on antennas



With several antennas, we want the fading on them to be as independent as possible.

E.g.: An antenna spacing of about 0.4 wavelength gives zero correlation.

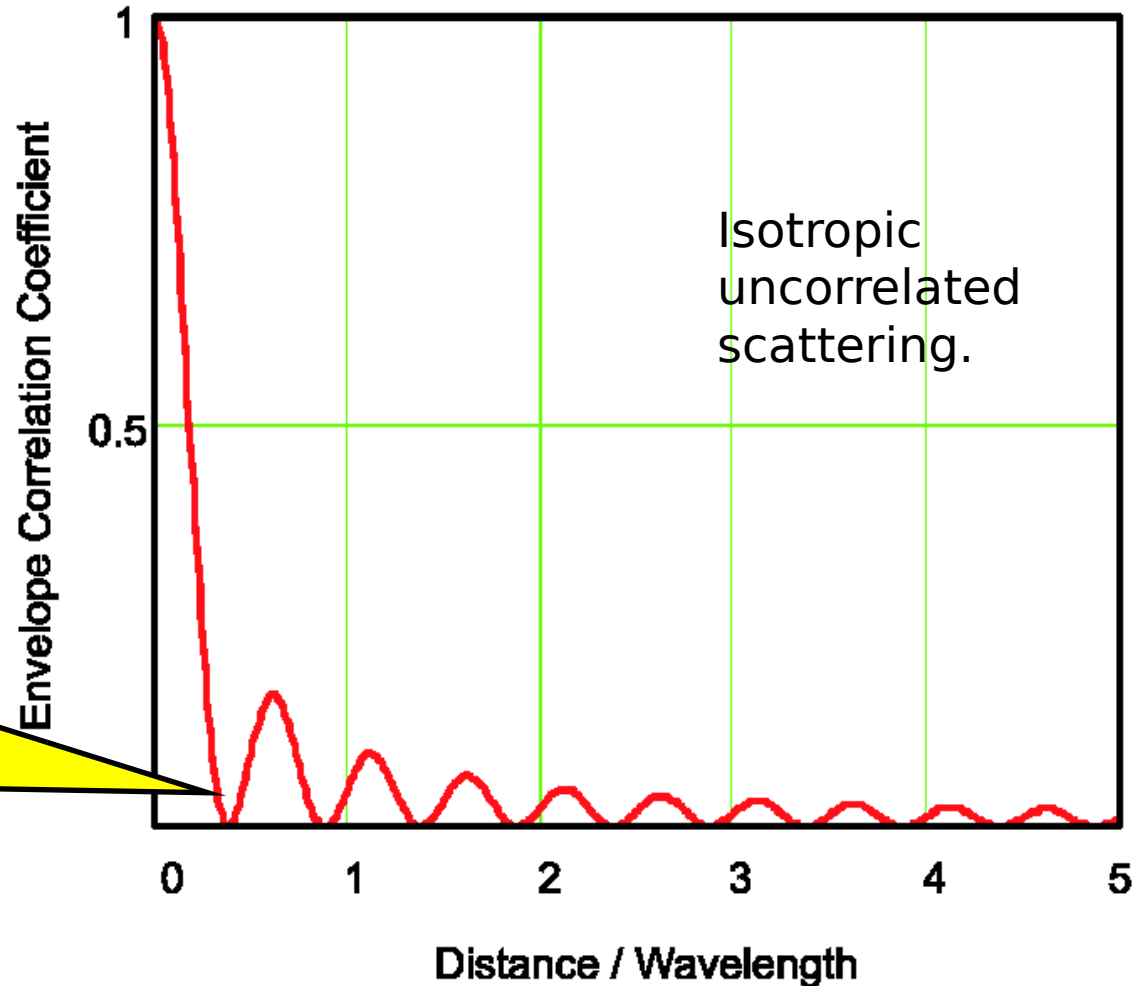

# Spatial (antenna) diversity

## Selection diversity

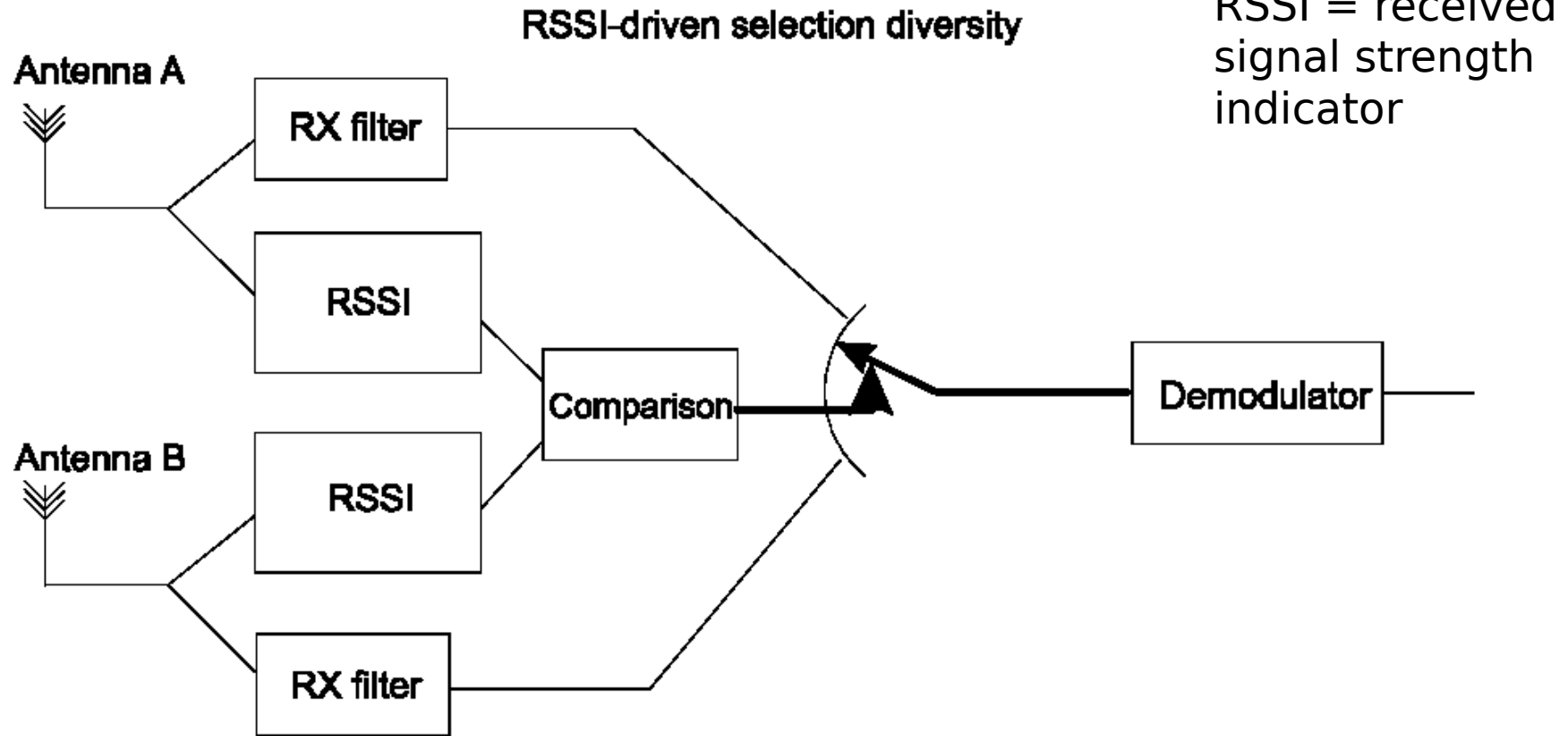

# Spatial (antenna) diversity

## Selection diversity, cont.



BER-driven selection diversity

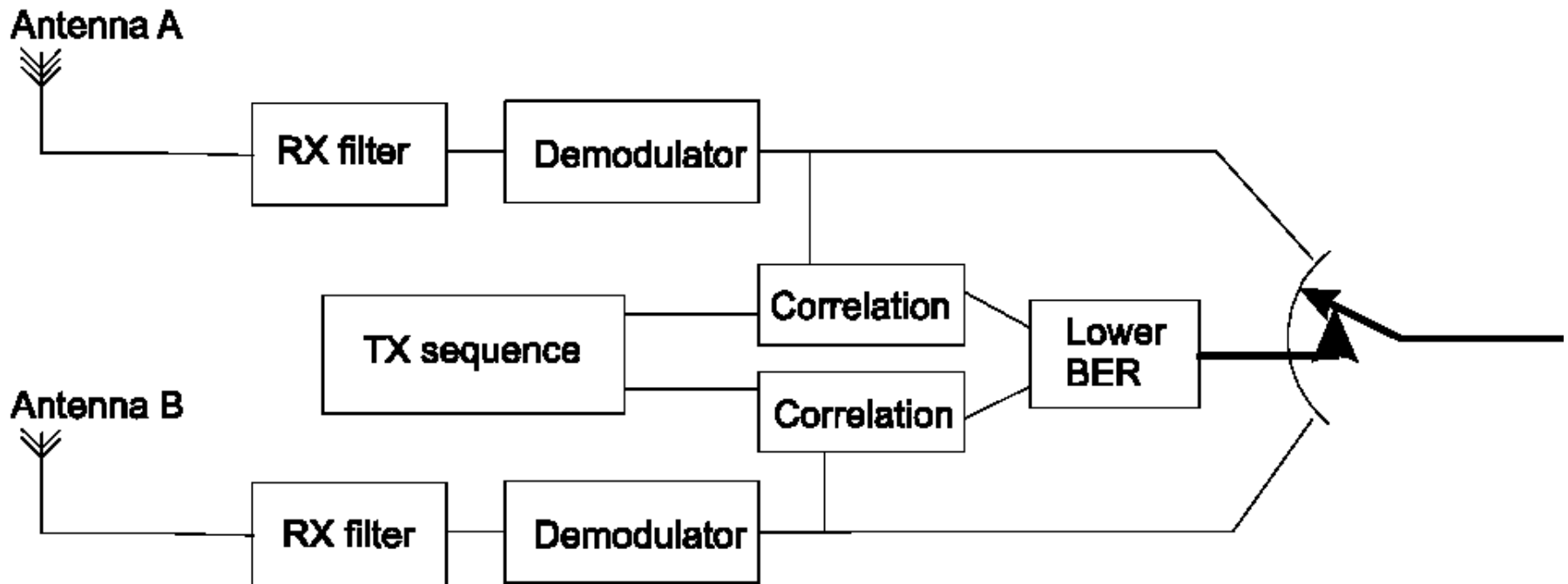

By measuring BER instead of RSSI, we have a better guarantee that we obtain a low BER.

# Spatial (antenna) diversity

## Maximum ratio combining

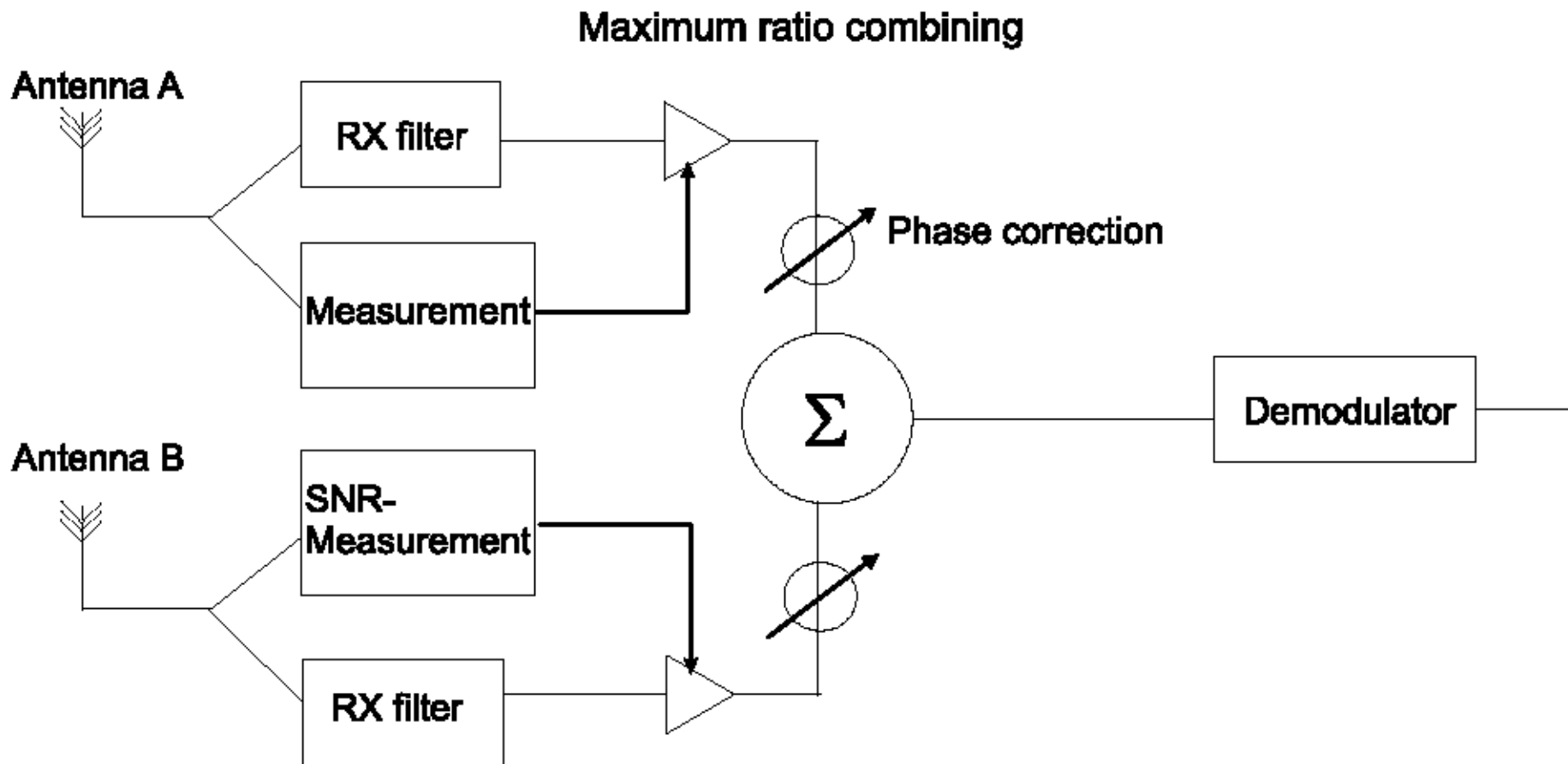

This is the optimal way (SNR sense) of combining antennas.

# Spatial (antenna) diversity



## Equal gain combining

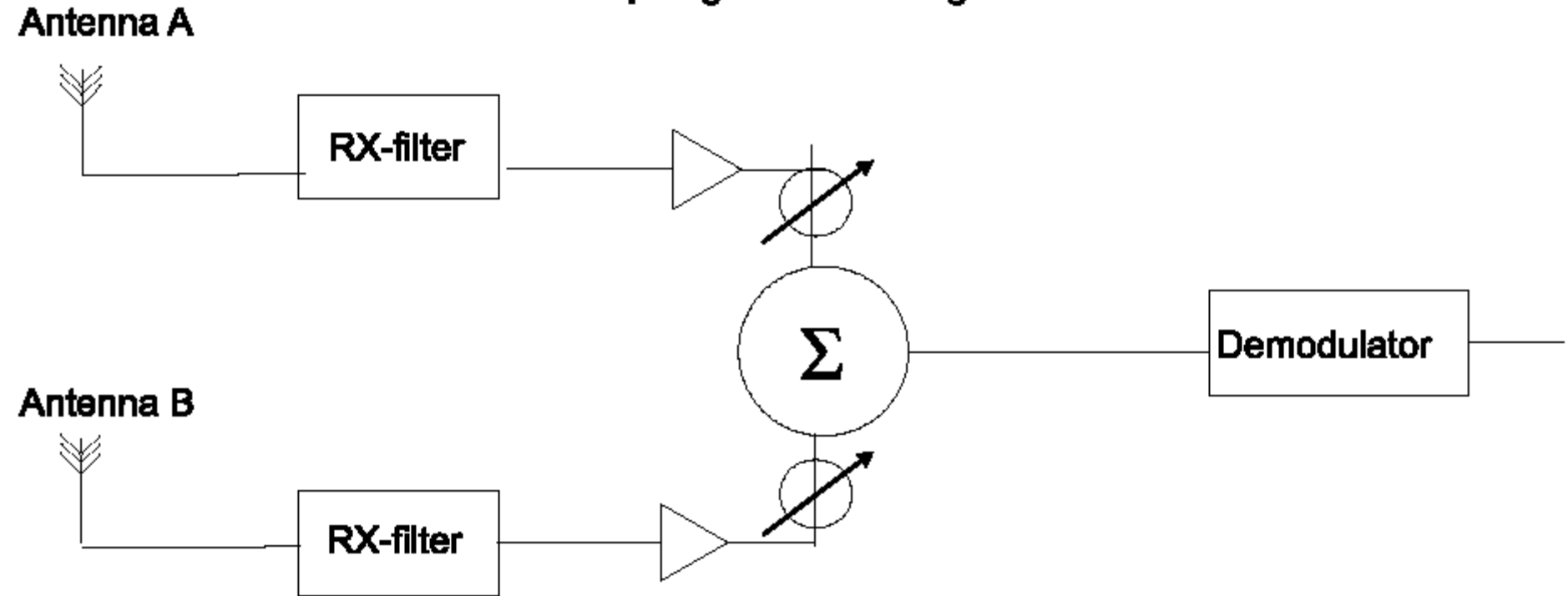

Simpler than MRC, but almost the same performance.

# Spatial (antenna) diversity Performance comparison



Comparison of SNR distribution for different number of antennas  $M$  and two different diversity techniques.

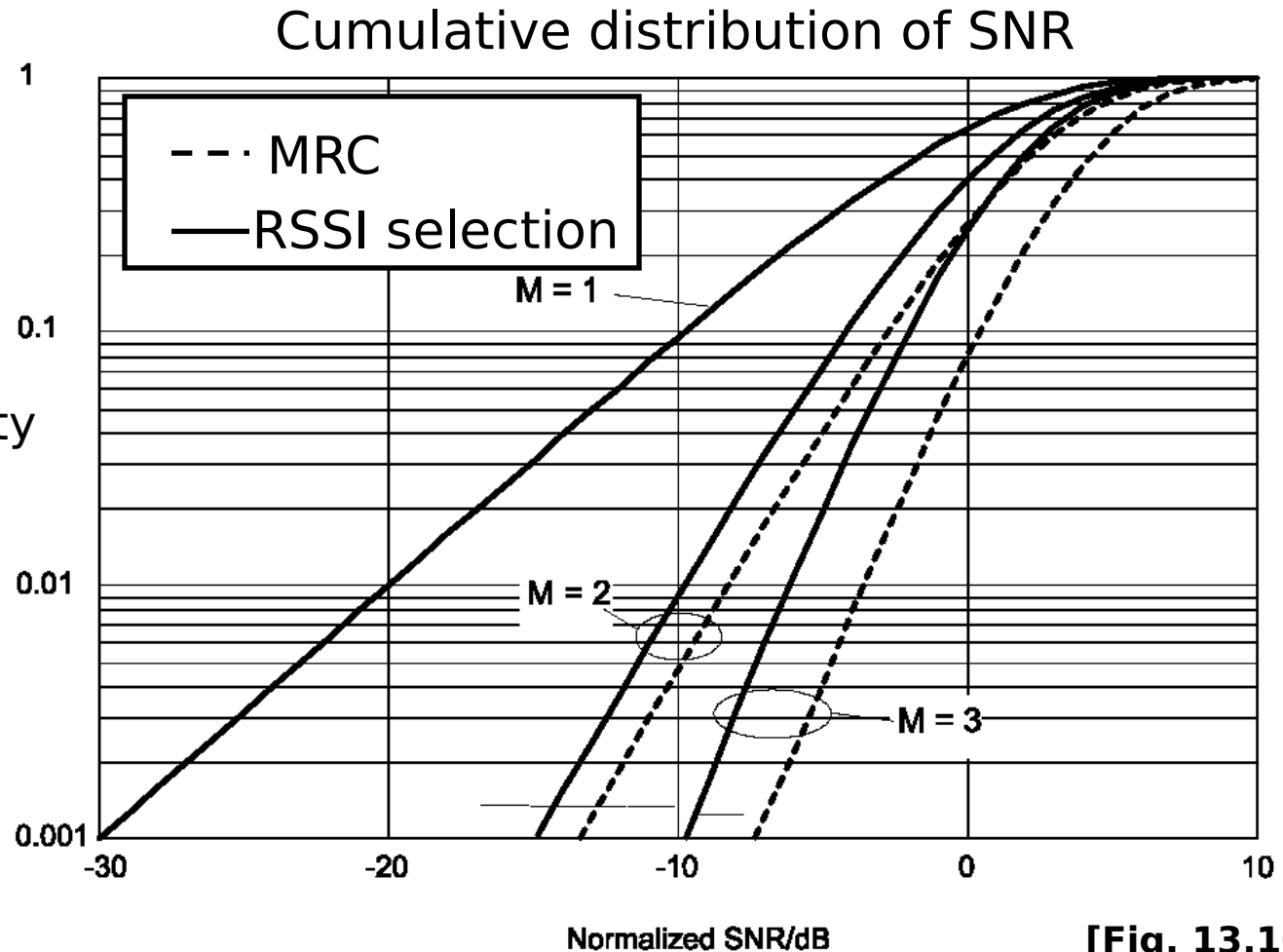

[Fig. 13.10]

These curves can be used to calculate fading margins.



# Spatial (antenna) diversity Performance comparison, cont.



Comparison of  
2ASK/2PSK BER  
for different number  
of antennas  $M$  and  
two different diversity  
techniques.

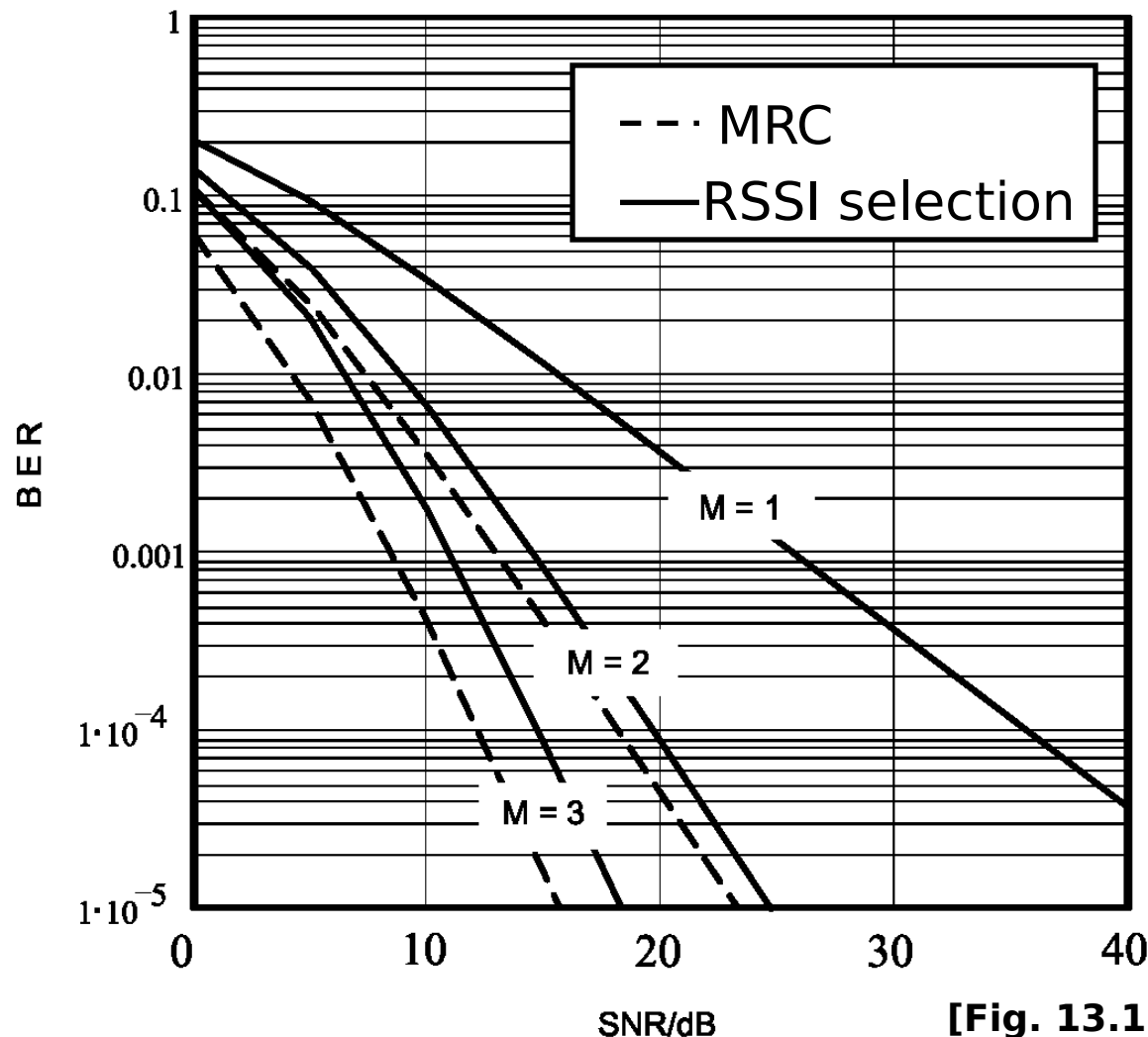

[Fig. 13.11]



# Summary

- Optimal (**maximum likelihood**) receiver in AWGN channels
- Interpretation of received signal as a point in a **signal space**
- Euclidean distances between symbols determine the **probability of symbol error**
- **Bit error rate** (BER) calculations for some signal constellations
- **Union bound** (better at high SNRs) can be used to derive approximate BER expressions
- **Fading** leads to serious BER problems
- **Diversity** is used to combat fading
- Focus on **spatial (antenna) diversity**
- Performance comparisons for **RSSI selection** and **maximum ratio combining** diversity.