

EITF25 – Internet: Technology and Applications

Physical Layer

IGMP

ICMP

IP

ARP

RARP

2015, Lecture 01

Kaan Bür

Underlying LAN or WAN
technology



A bottom-up approach

- **Principles of digital communications**
 - From electrical signals to bits to packets
- Using the physical infrastructure
 - Network access
- Finding your way
 - Addressing, routing
- Making use of it all
 - Applications

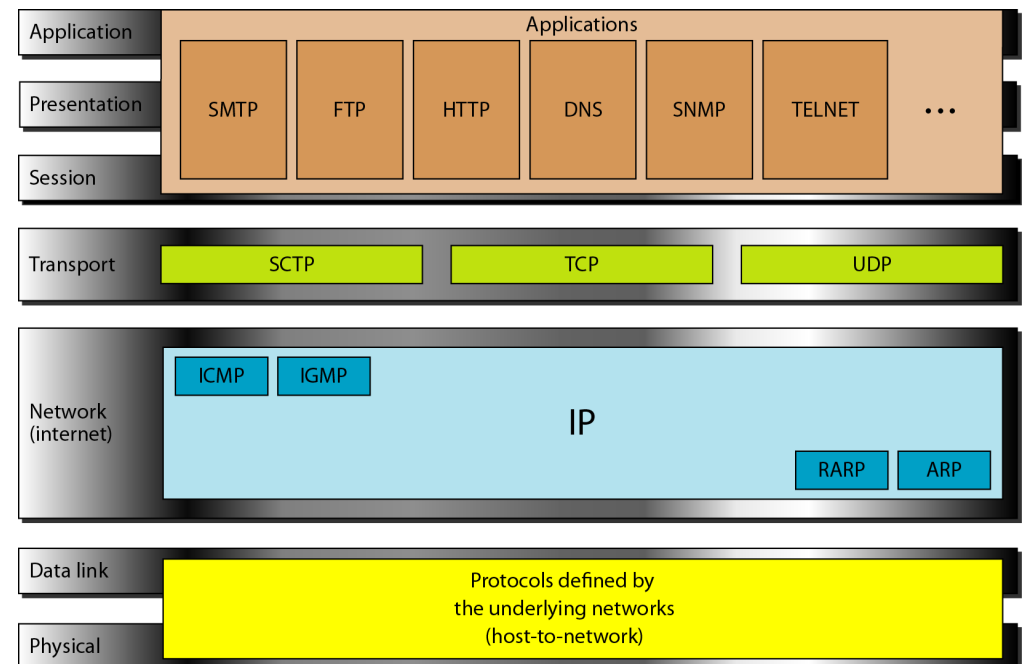

Introduction

- Data
- Communication
- Network

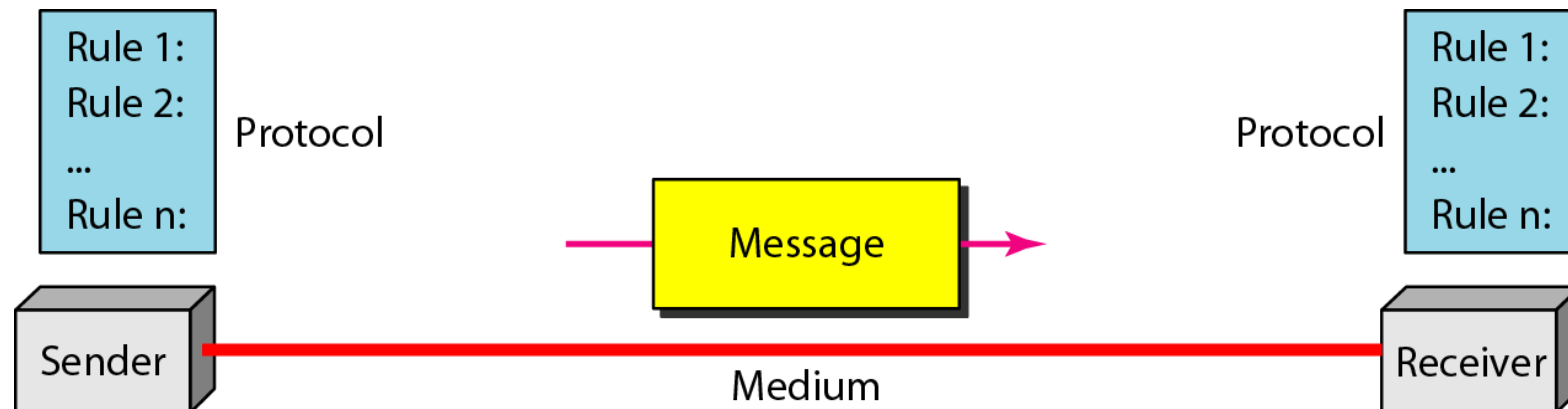

Network topologies *[S11.1][F1.1-2][K1.5-6]*

- Layout of links and nodes

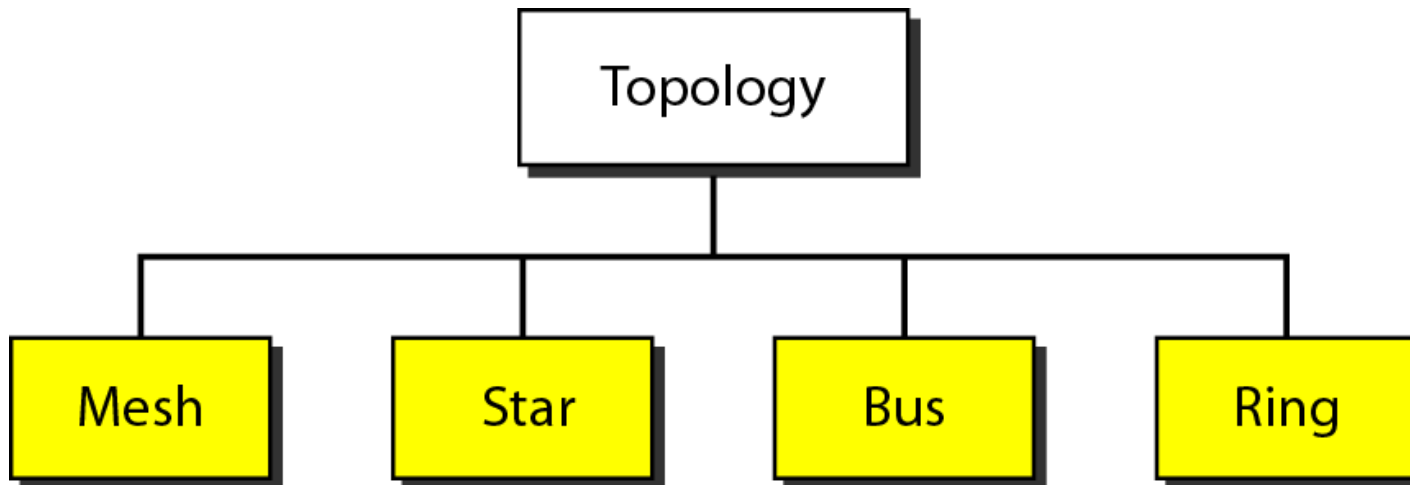

Mesh network

- Redundant links

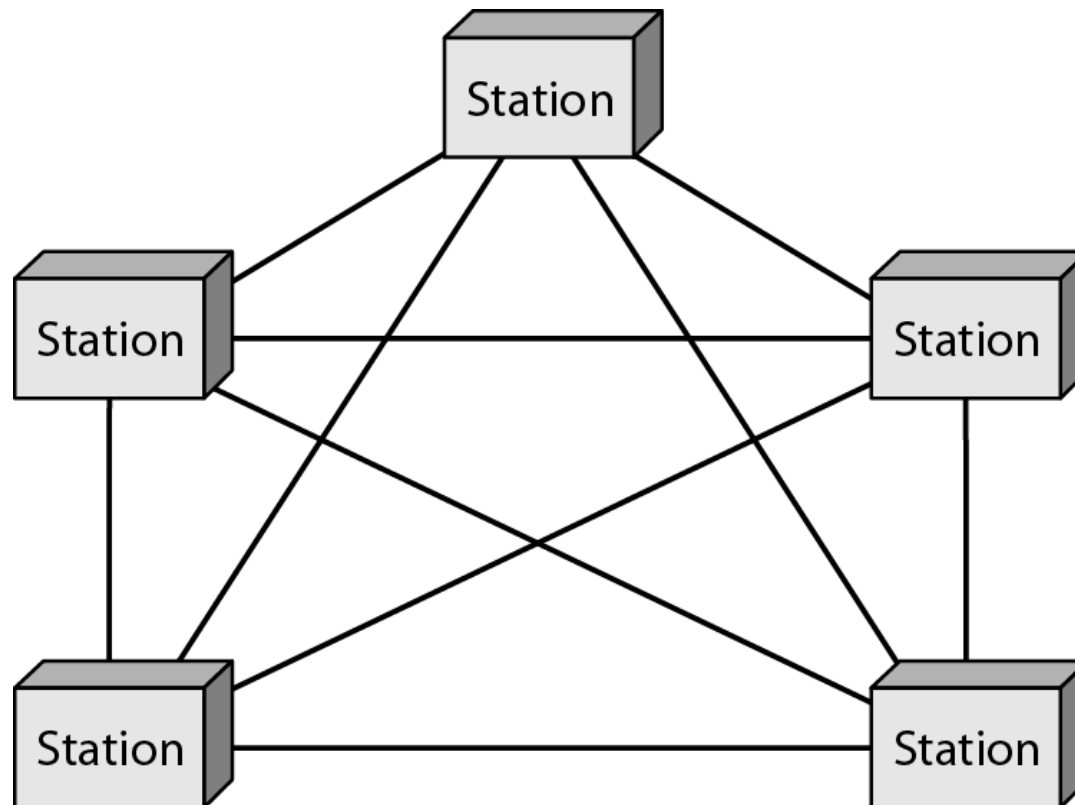

Star network

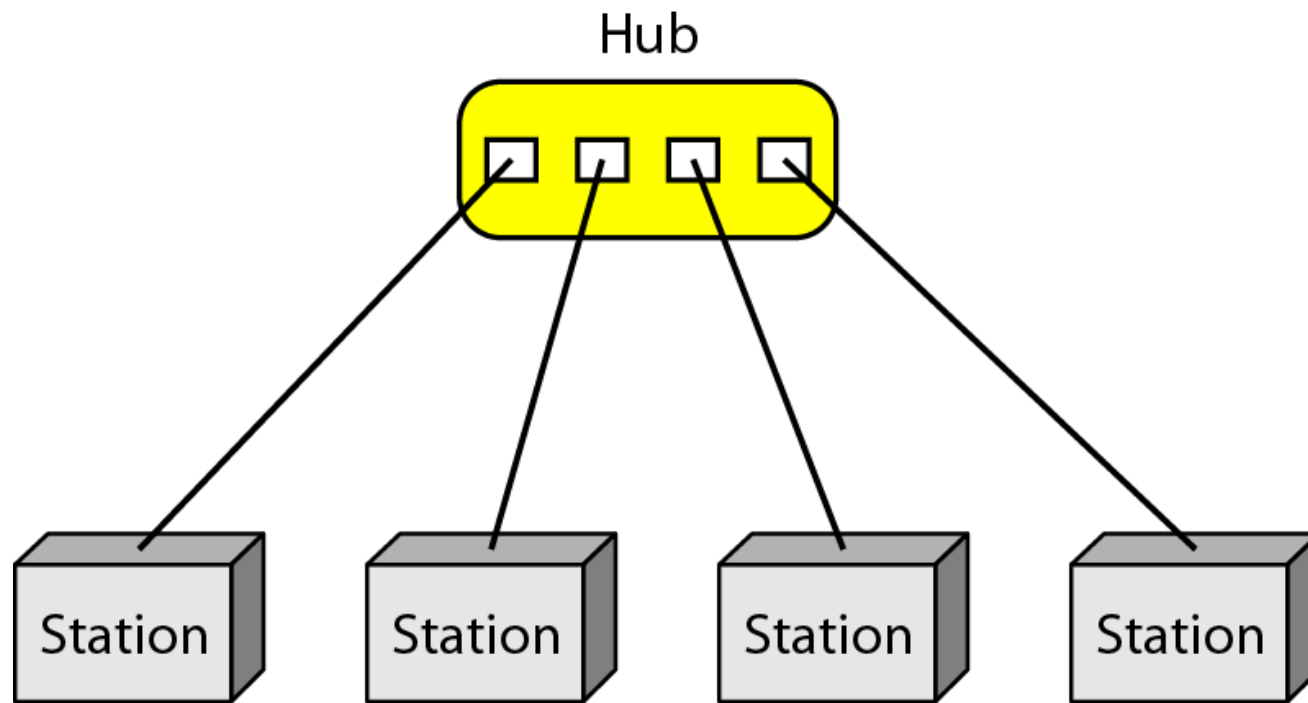

Bus network

- Simple
- Vulnerable to collisions

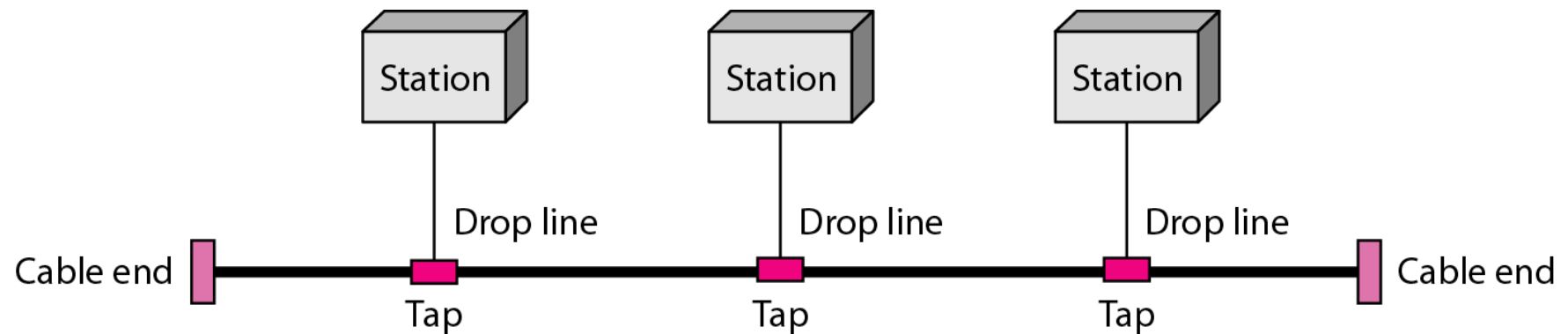

Ring network

- Circular
- Susceptible to node failures

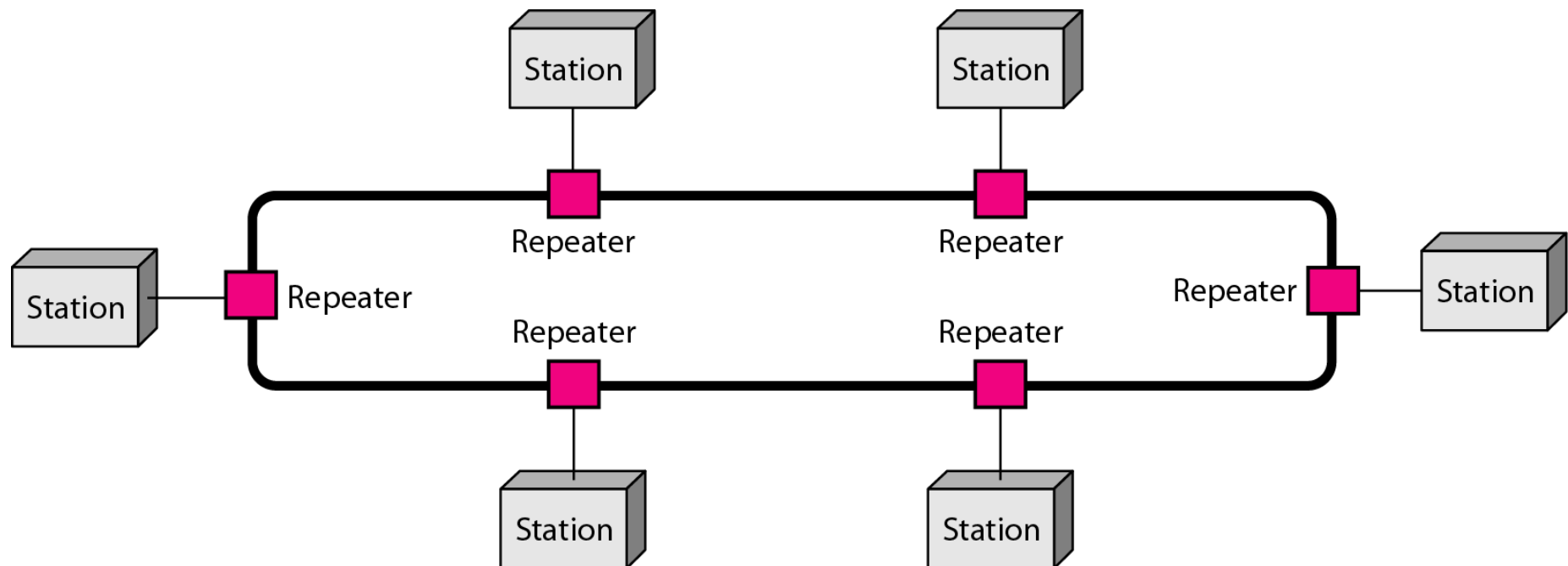

Internet: Physical Layer

- Data and Signals *[S3.1-4][F3.1-4]*
 - Analog, digital
- Conversion to Digital *[S5.1; S5.3][F4.1-2]*
 - Coding
- Conversion to Analog *[S5.2][F5.1]*
 - Modulation
- Multiplexing *[S8.1-2][F6.1]*

**[Kihl & Andersson: 2.1-3, 3.1-2, 3.5-6]*

Data vs Signal

- Data: Static representation of information
 - For storage
- Signal: Dynamic representation of information
 - For transmission

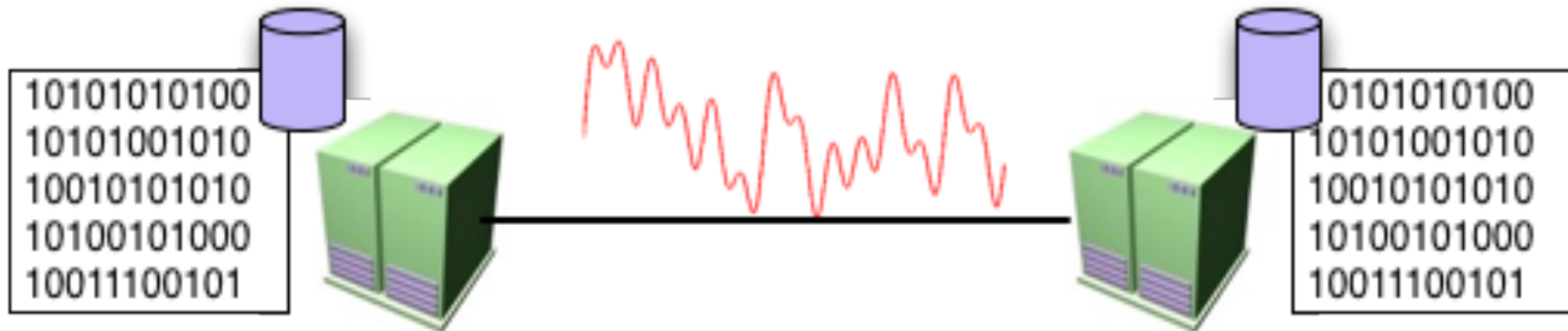

Analog vs Digital

- Analog → continuous
- Digital → discrete

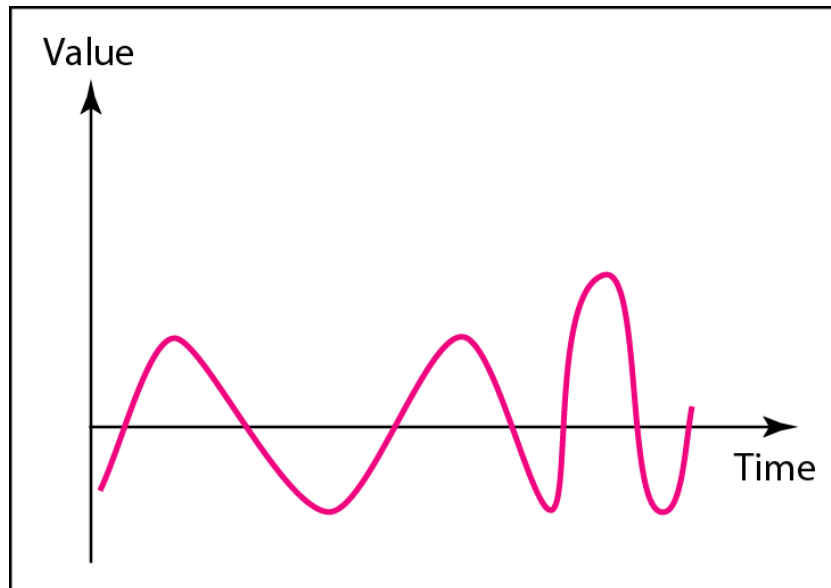

a. Analog signal

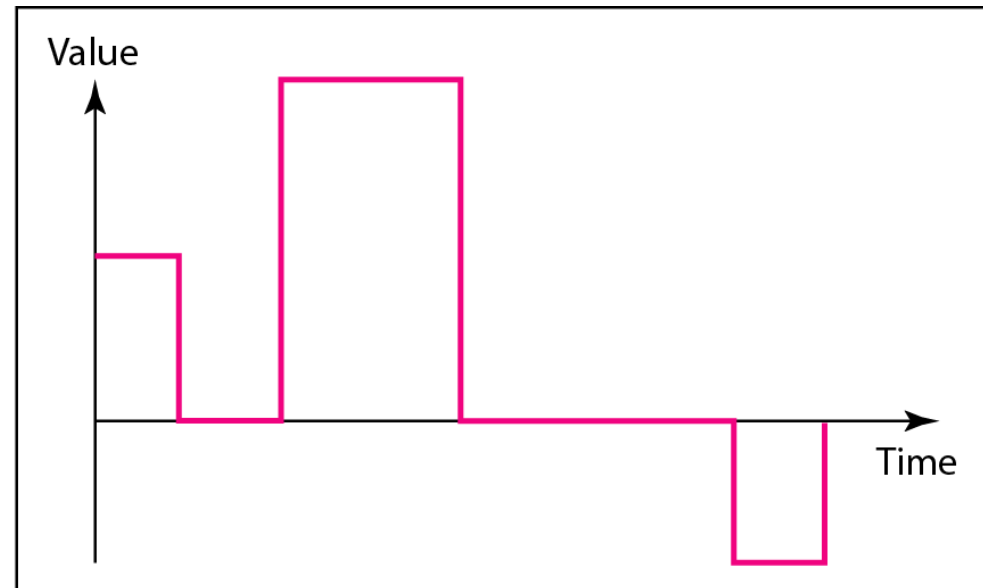

b. Digital signal

Digitalization of analog signals

- Performed in three steps:
 1. Sampling
 - Discretization in time
 2. Quantization
 - Discretization in amplitude
 3. Encoding
 - Binary representation of amplitude levels

Sampling

- The process of discretizing the time of a continuous function.

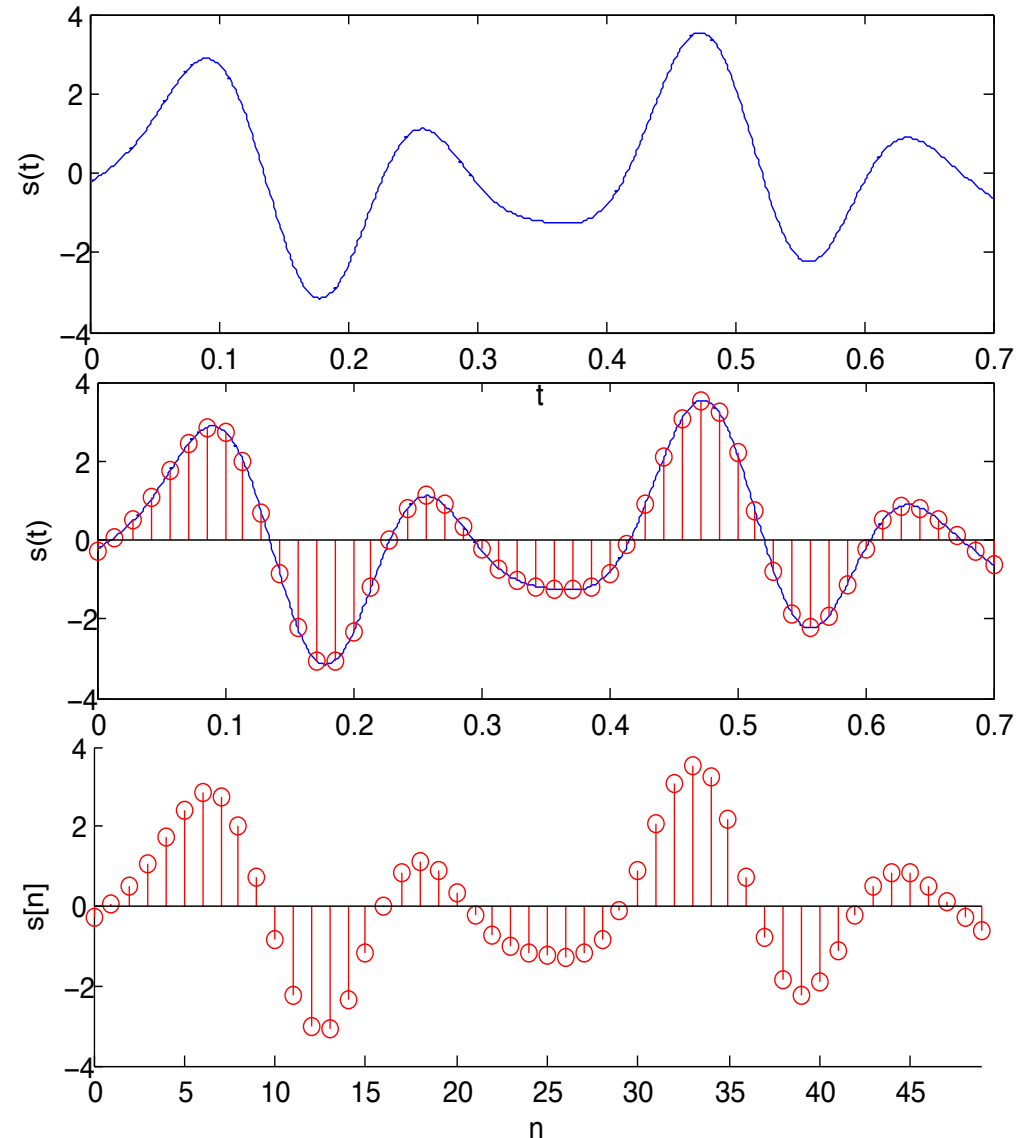

Nyquist Sampling Theorem

- If $s(t)$ is a band limited signal with highest frequency component F_{max} , then $s(t)$ is uniquely determined by the samples $s_n = s(nT)$ if and only if

$$F_s = \frac{1}{T} \geq 2F_{max}$$

- The signal can be reconstructed with

$$s(t) = \sum_n s_n \operatorname{sinc}\left(\frac{t - nT}{T}\right)$$

- F_{max} is the Nyquist frequency and F_s the Nyquist rate

Data Rate vs Signal Rate

Data Rate

- Number of bits transmitted per second
- Unit b/s or bps
- Often denoted R_b

Signal Rate

- Number of signal alternatives transmitted per second
- Unit Hz (sometimes baud)
- Often denoted T_s
- If there are k bits/signal
 - $R_b = kT_s$

Example: Bit rate for telephony links

- Analog signal in frequencies from 0 to 4kHz
- Nyquist theorem → sampling frequency
 - $2 \times 4000 \text{ Hz} = 8000 \text{ Hz}$ (samples per second)
- 8-bit encoding
 - $8000 \text{ Hz} \times 8 \text{ bits} = 64000 \text{ bits/s}$



The bit rate is 64 kbps.

How sampling rate affects the result

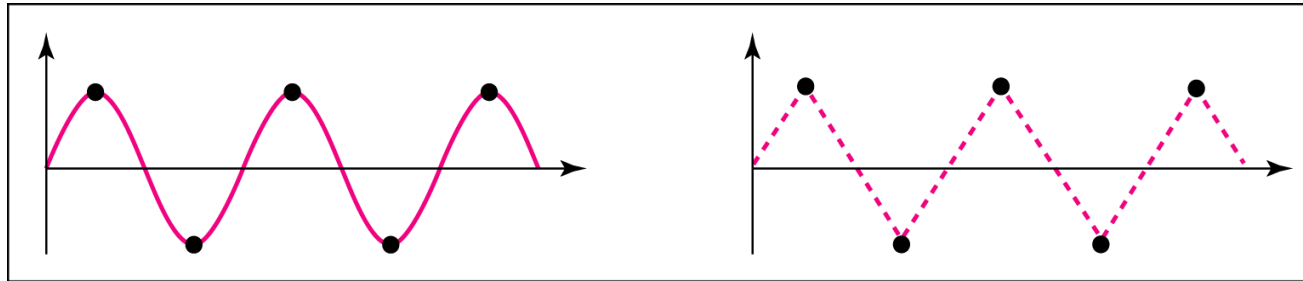

a. Nyquist rate sampling: $f_s = 2 f$

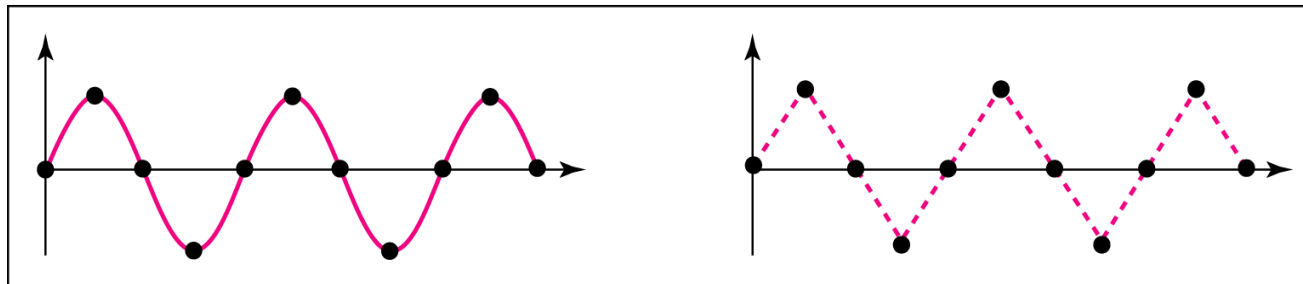

b. Oversampling: $f_s = 4 f$

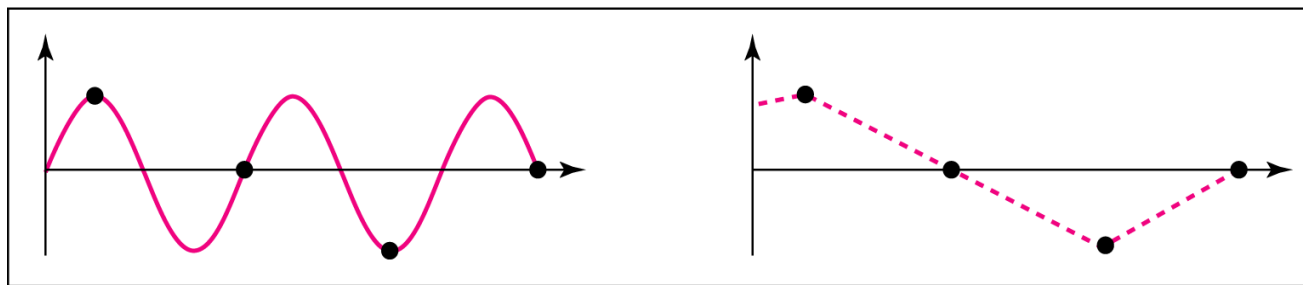

c. Undersampling: $f_s = f$

Quantization

- Linear Quantization
 - 2^N equidistant levels
 - Represent sample with N bits
- Telephony
 - $N=8 \rightarrow 256$ levels
- CD
 - $N=16 \rightarrow 65\,536$ levels

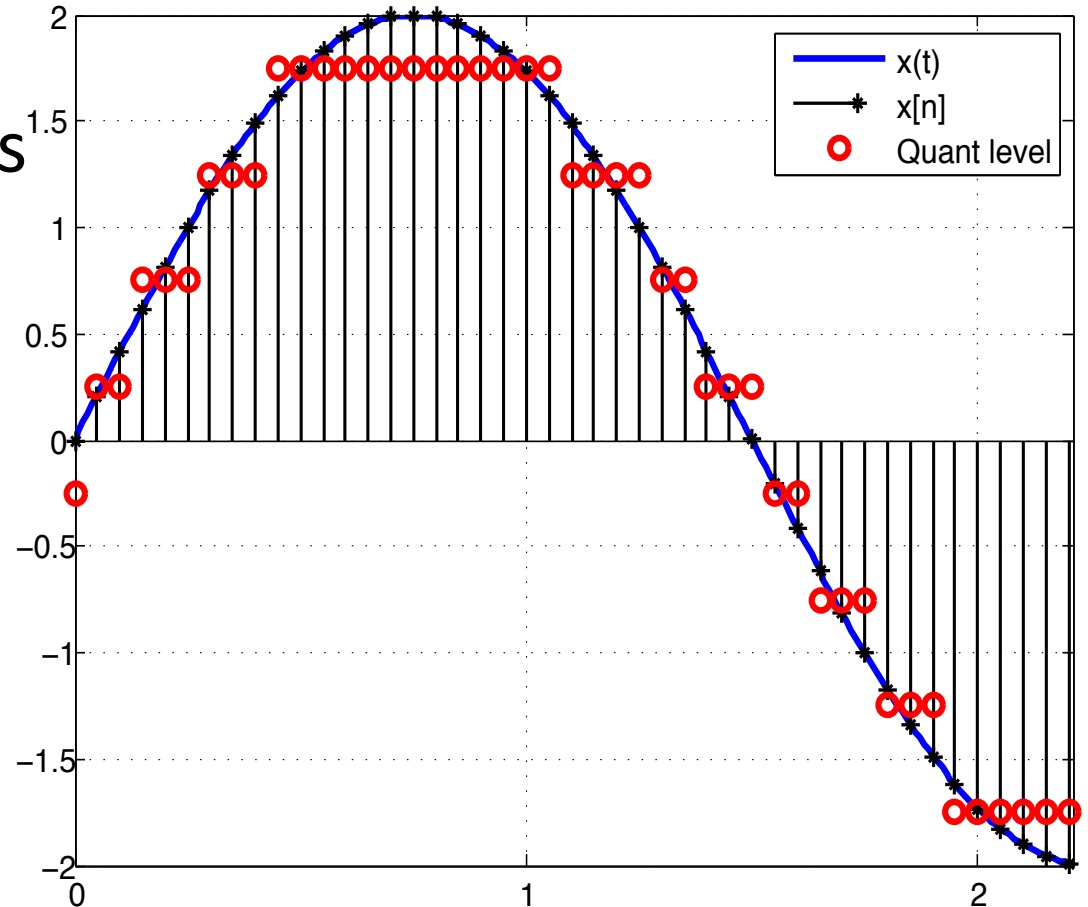

Quantization

- Delta modulation
 - Represent change in amplitude with 1 bit

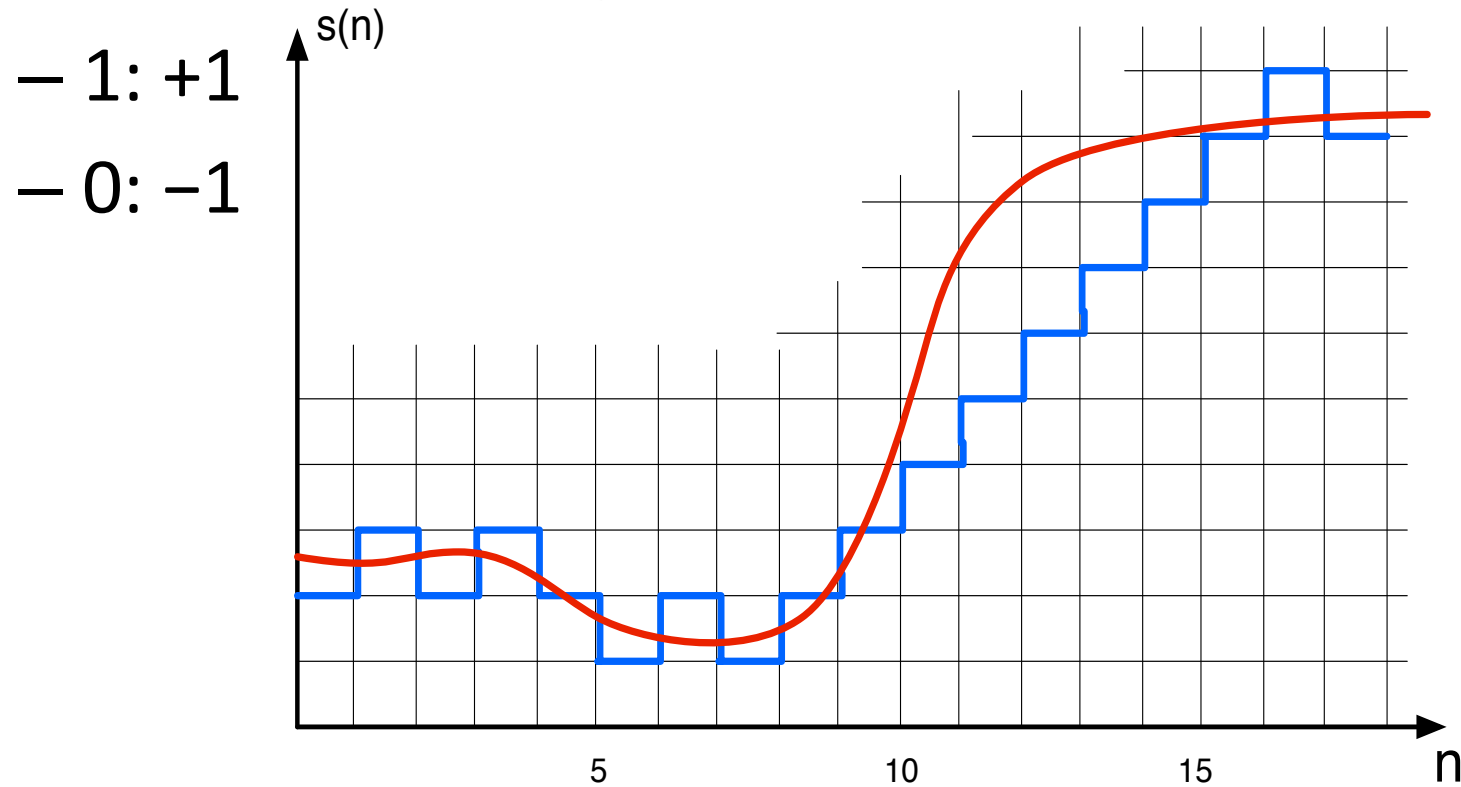

Encoding

- Representation of quantized samples in bits

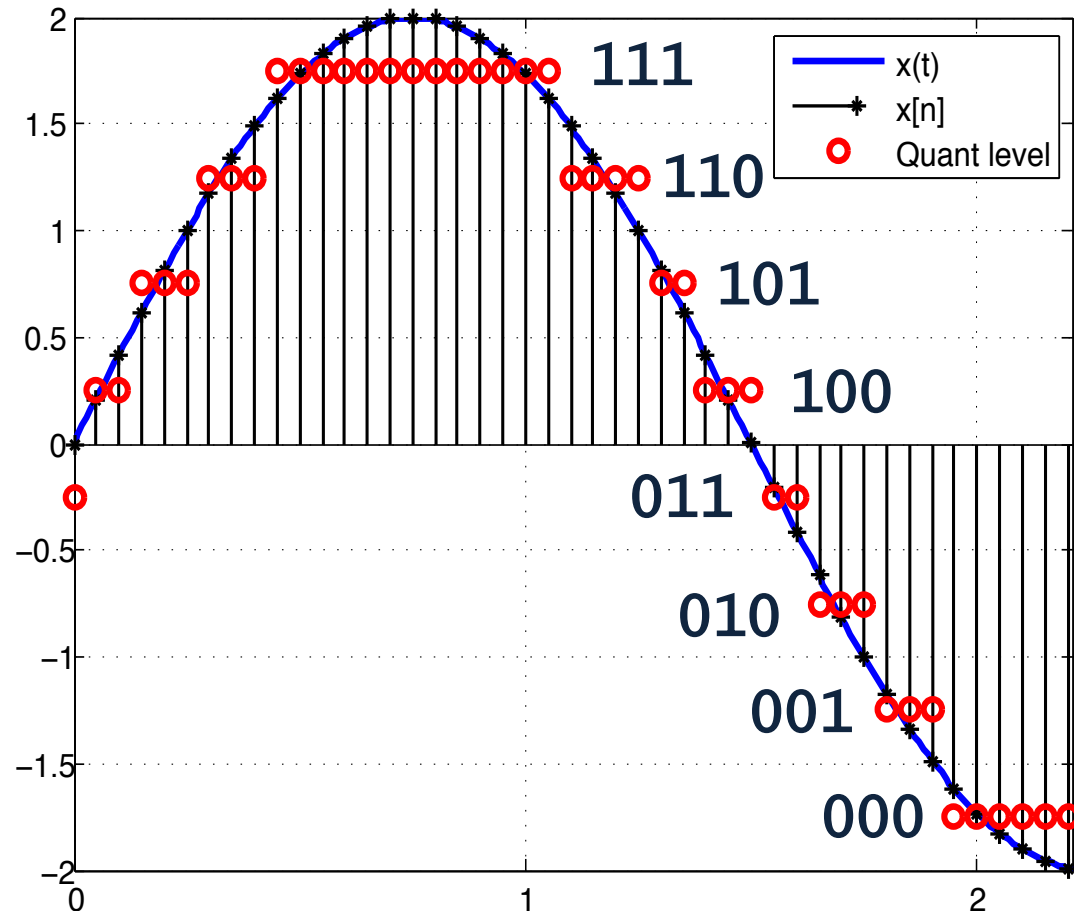

From bits to digital signals

- Transmission medium
 - Twisted pair
 - Coaxial
 - Optical fibre
 - Air

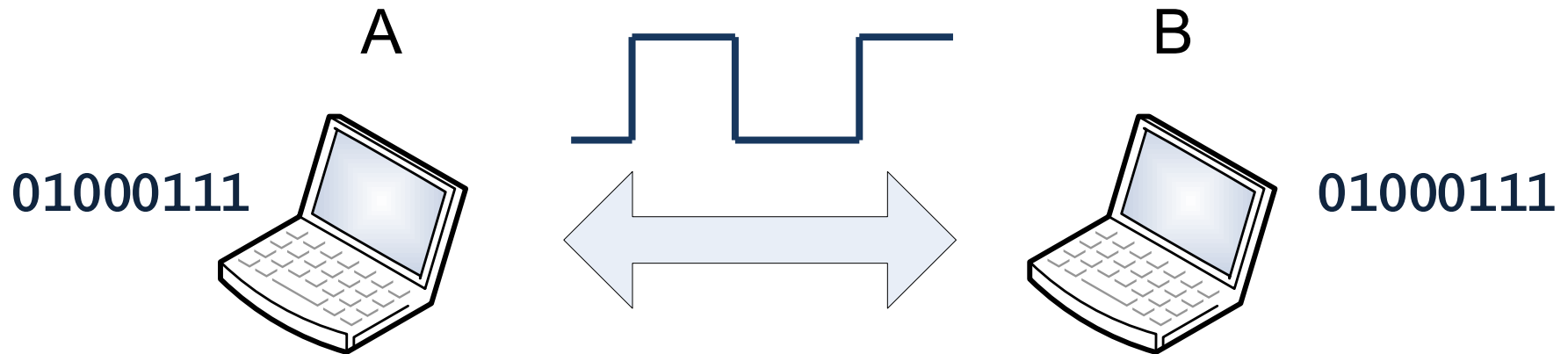

Digital signal transmission

- Signals coded by changes in voltage amplitude

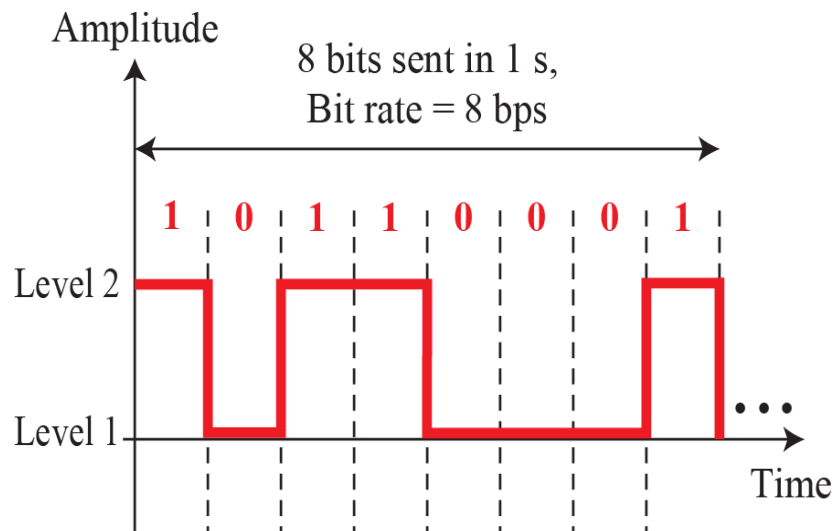

a. A digital signal with two levels

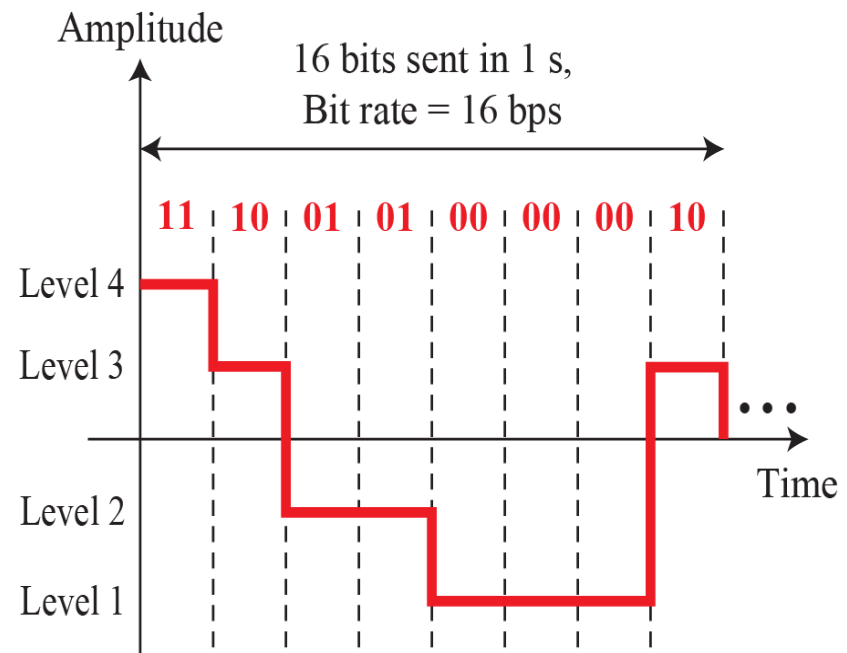

b. A digital signal with four levels

Non-Return to Zero (NRZ-L)

- 0 = high voltage amplitude
- 1 = low voltage amplitude

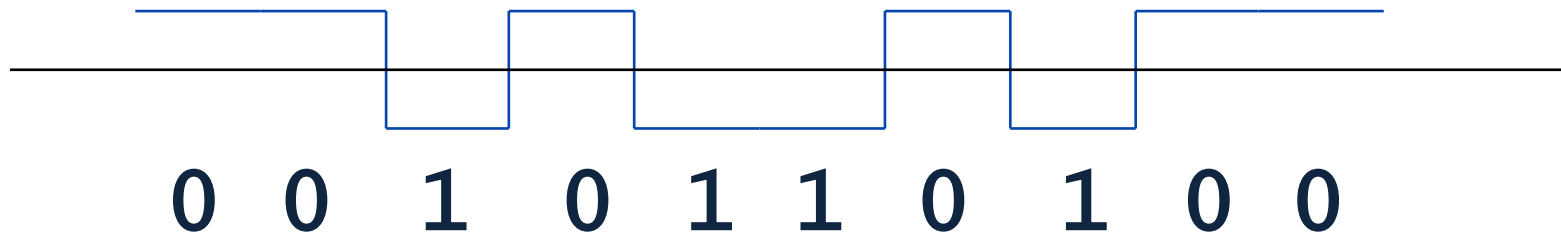

- Synchronisation problem

Manchester Coding

- Combines NRZ with a clock pulse

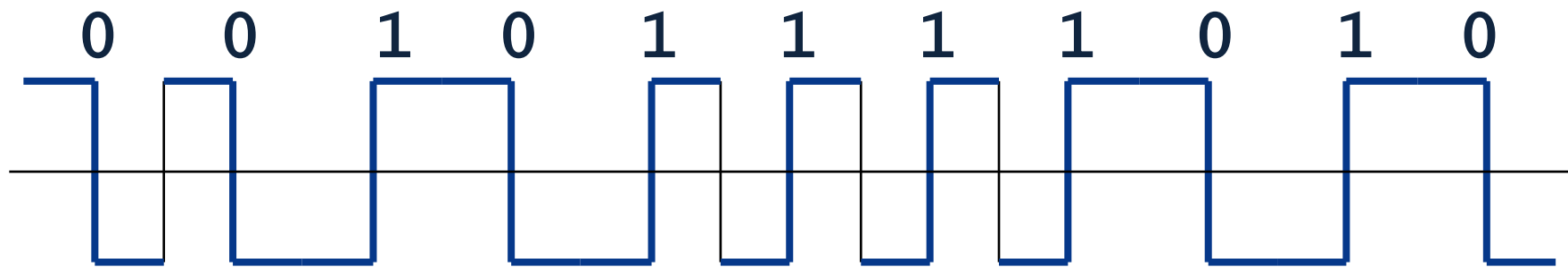
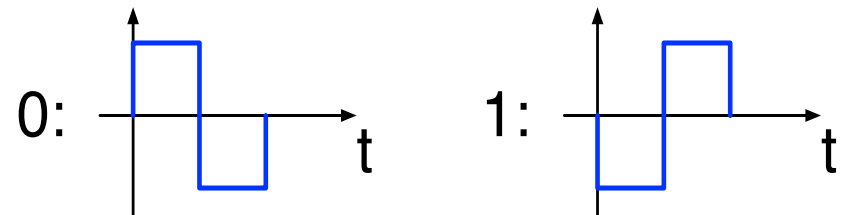

Differential Manchester

- 0 = Inversion at the beginning of the bit
- 1 = No inversion at the beginning of the bit

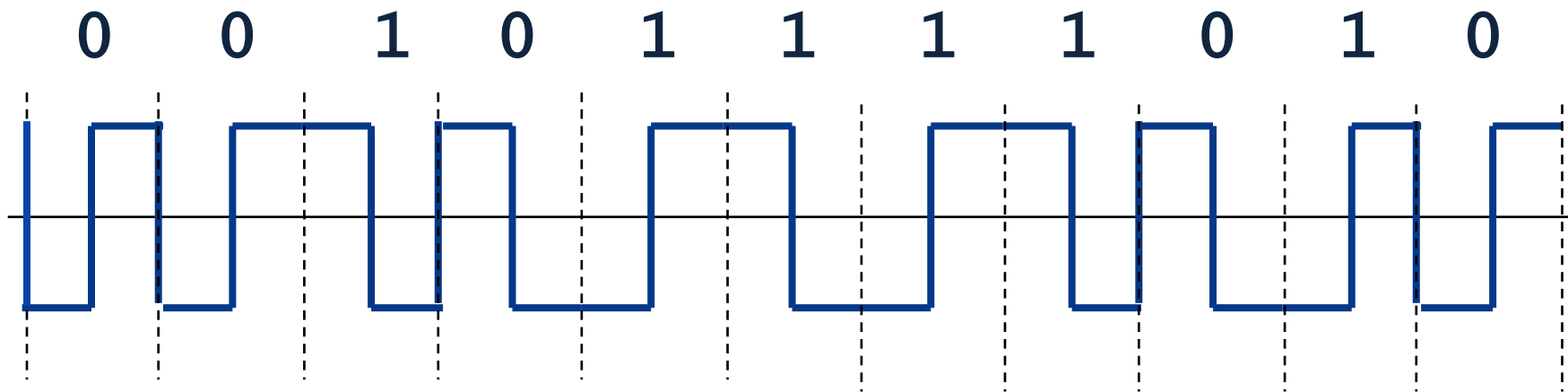

See you in 15' :)



- After the break
 - Analog transmission
 - Transmission impairment
 - Multiplexing

Analog transmission

- Used in wireless communications
- Uses a technique called "modulation"
- Digital data represented by sinus waves

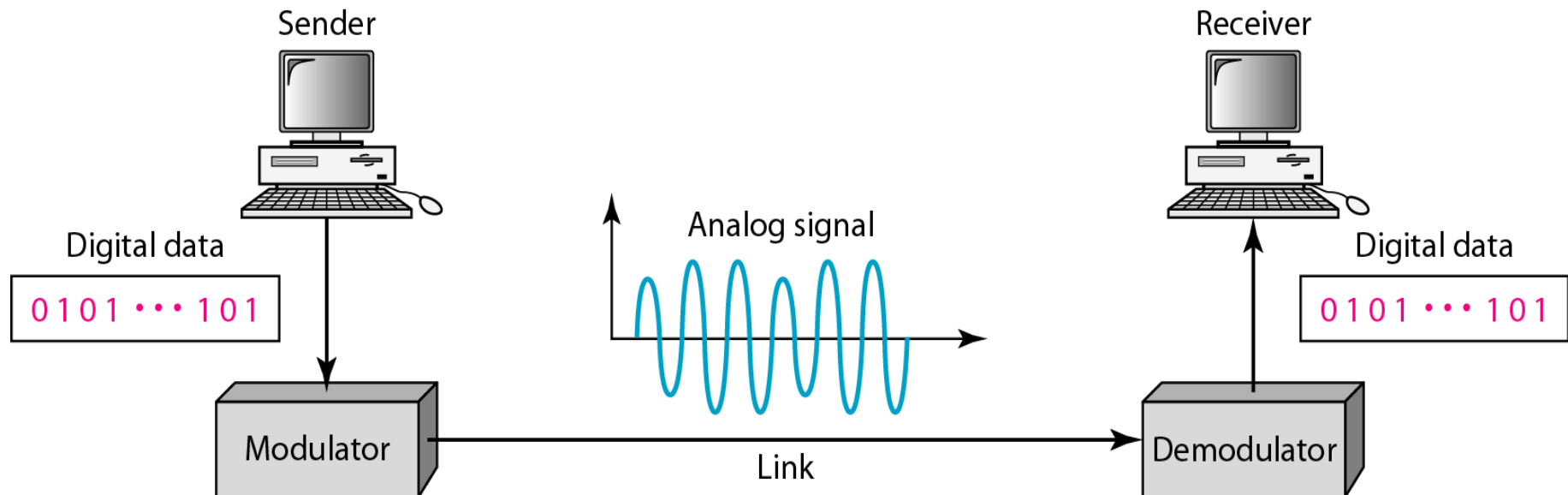

Types of modulation schemes

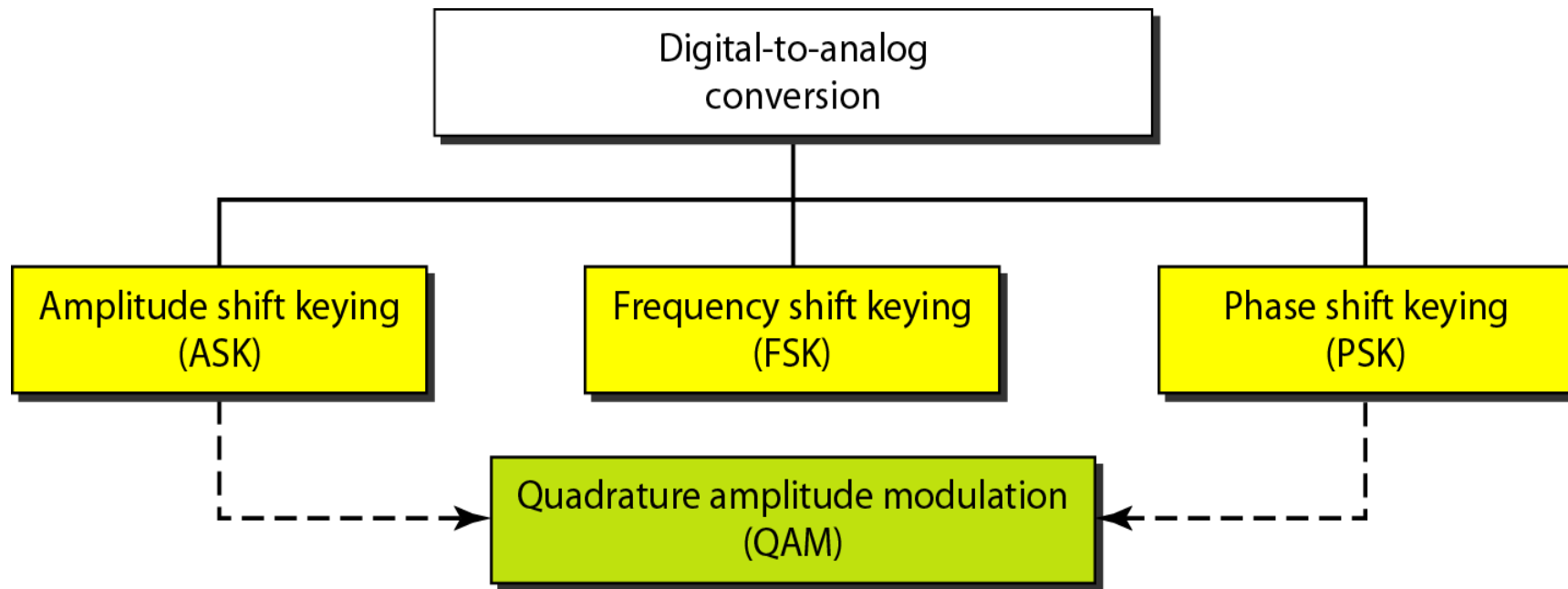

Amplitude Shift Keying (ASK)

- Varies amplitude of carrier signal
- A.k.a. Pulse Amplitude Modulation (PAM)

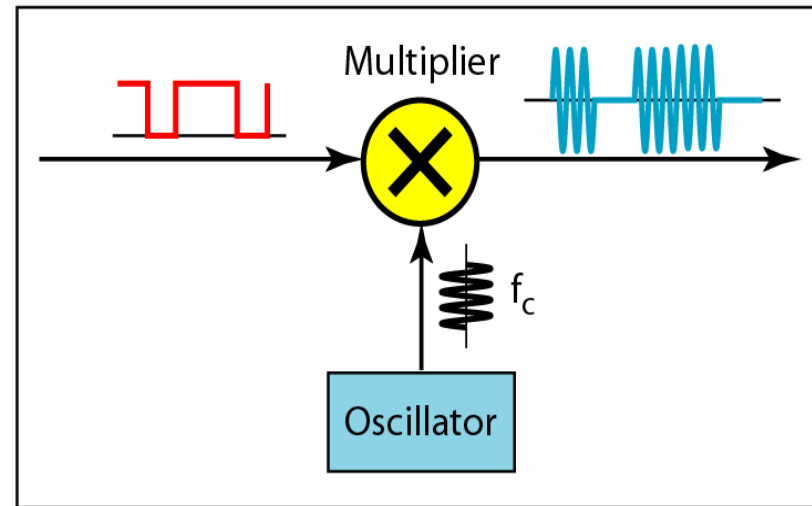
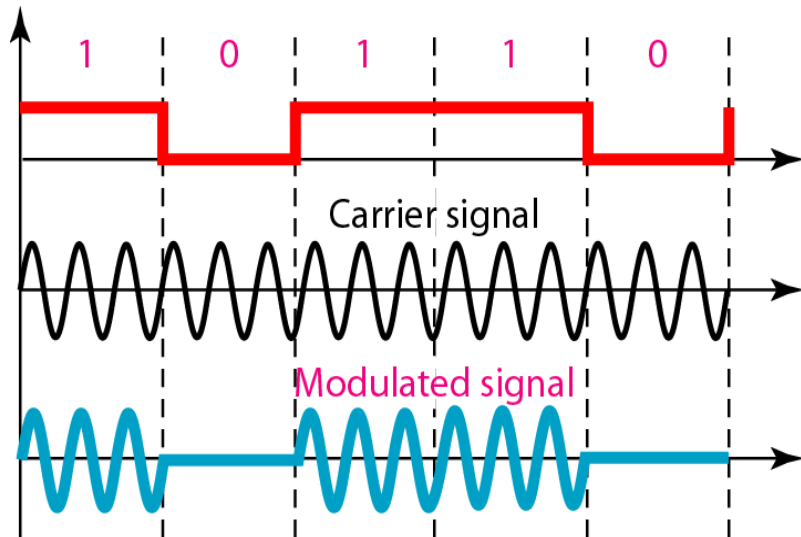

Frequency Shift Keying (FSK)

- Varies frequency of carrier signal

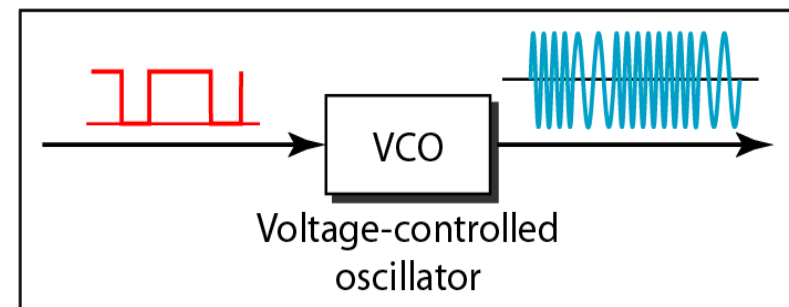
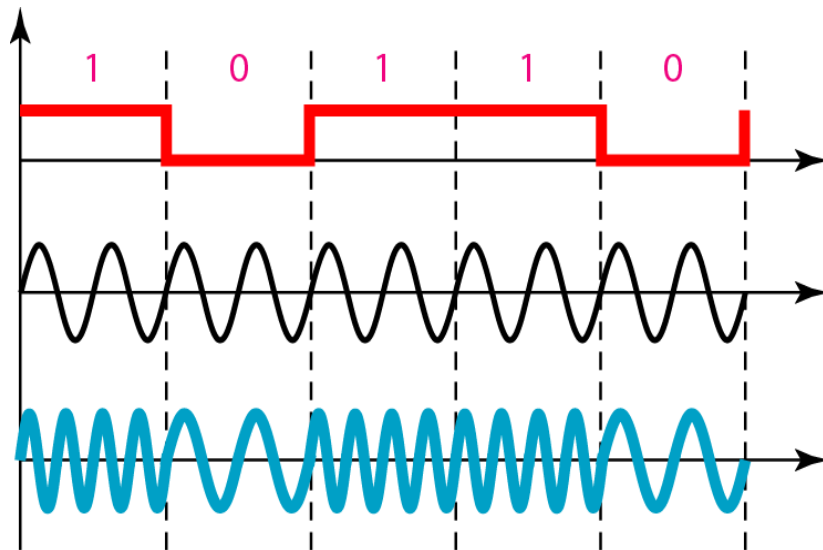

Phase Shift Keying (PSK)

- Varies phase of carrier signal

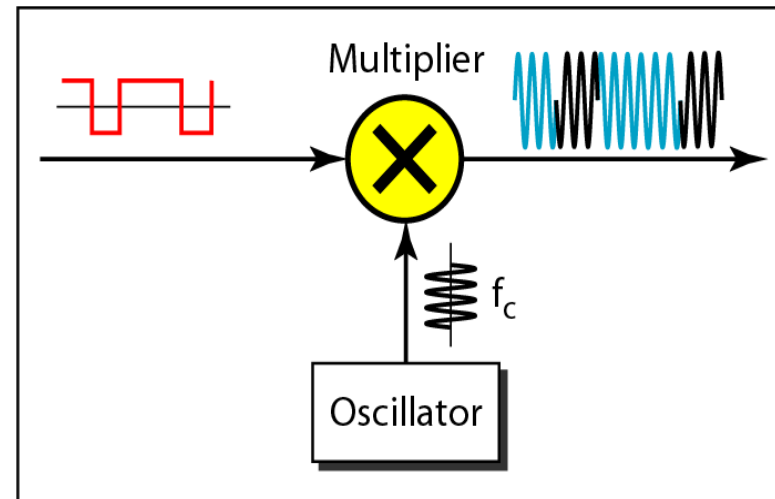
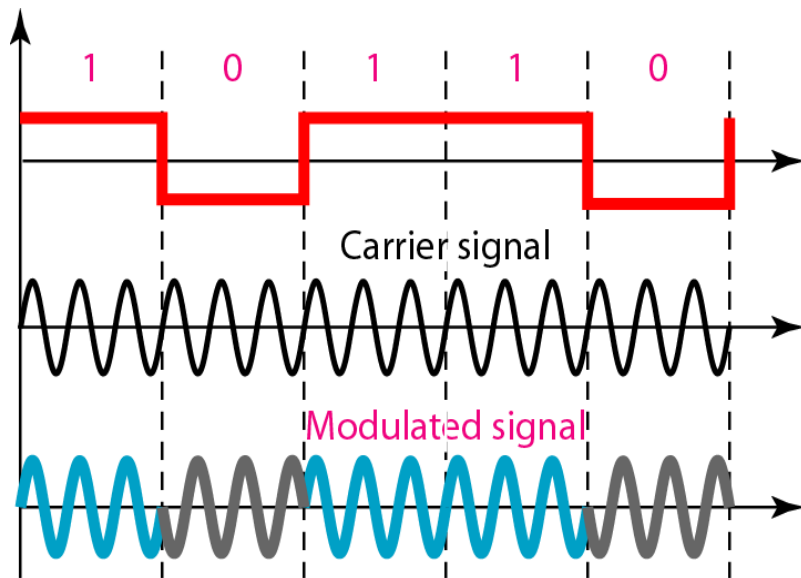

Transmission impairment

- When a signal travels on a link, it deteriorates due to transmission impairment.
 - Attenuation
 - Distortion
 - Noise

$$\text{Signal-to-noise ratio (SNR)} = \frac{\text{Average signal power}}{\text{Average noise power}}$$

Attenuation

- Loss of energy

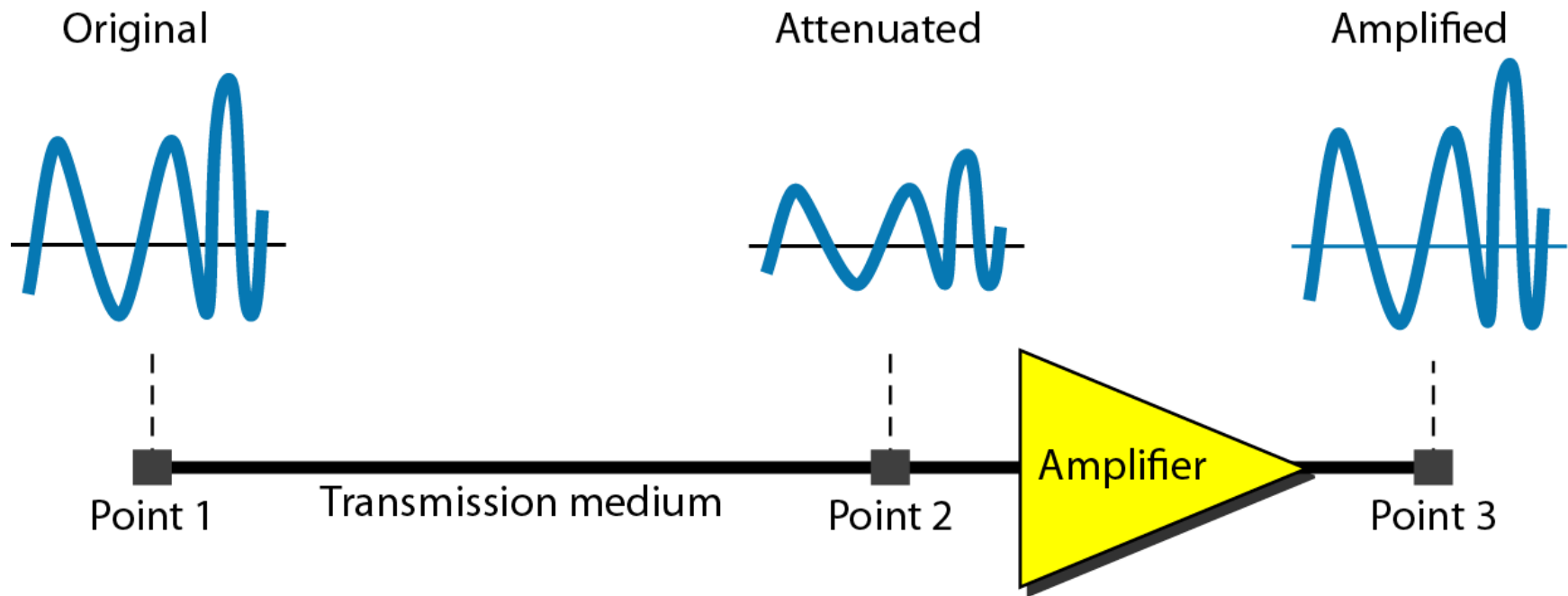

Distortion

- Change in signal shape

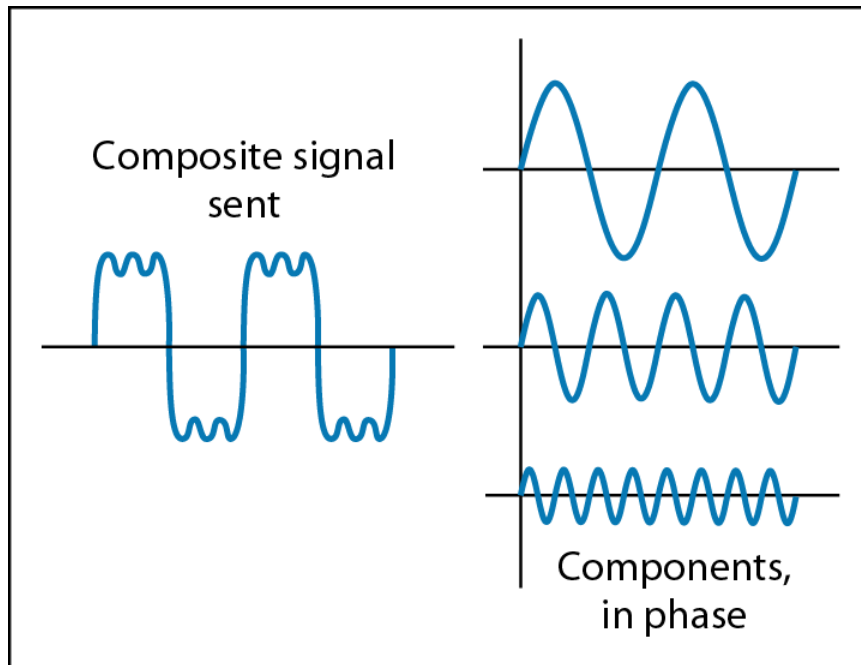

At the sender

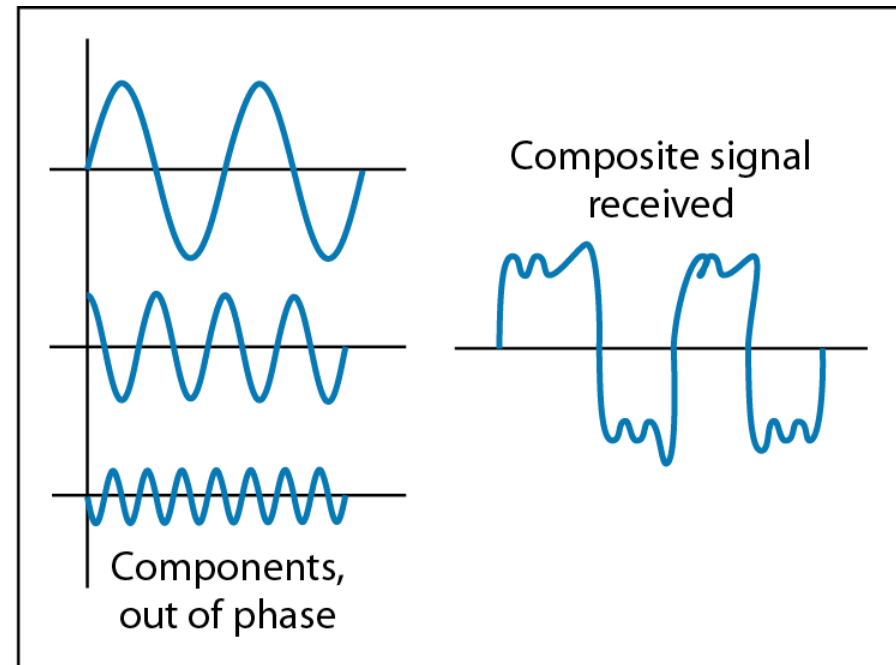

At the receiver

Noise

- Corruption due to e.g. thermal noise or crosstalk

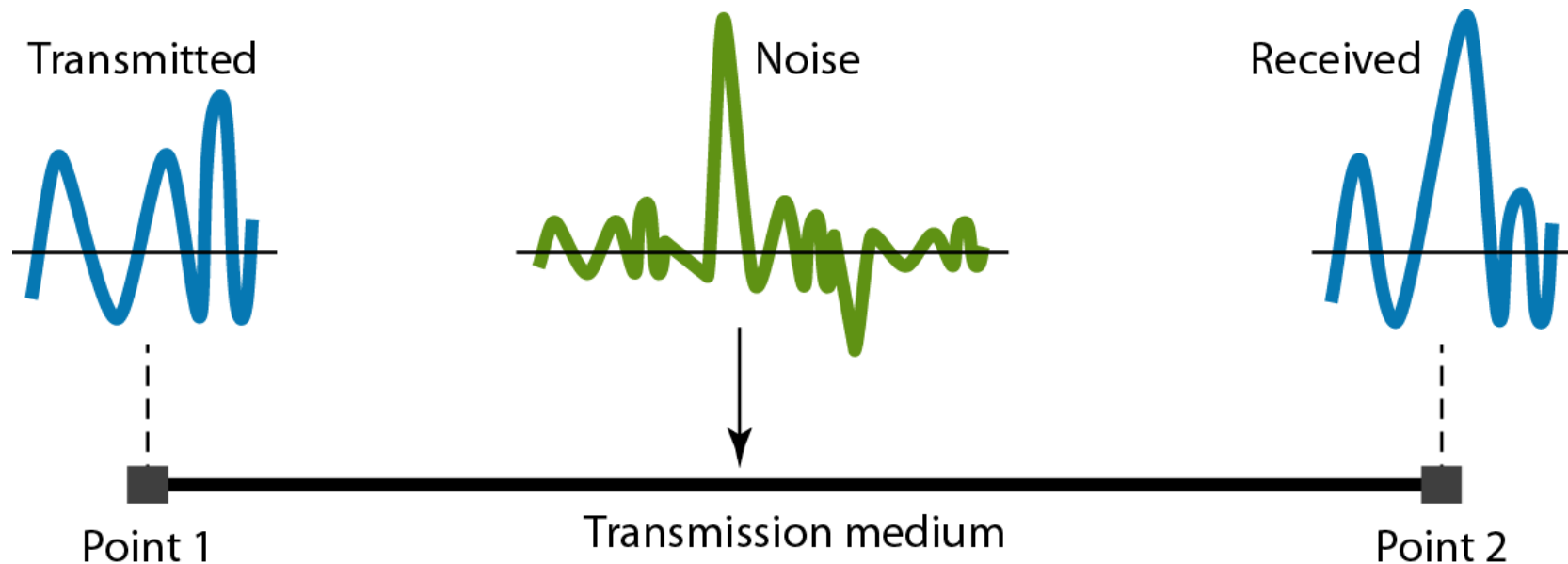

Multiplexing

- Why?
 - Two computers transmitting data on a link cannot do this simultaneously on the same frequencies with the same coding scheme.

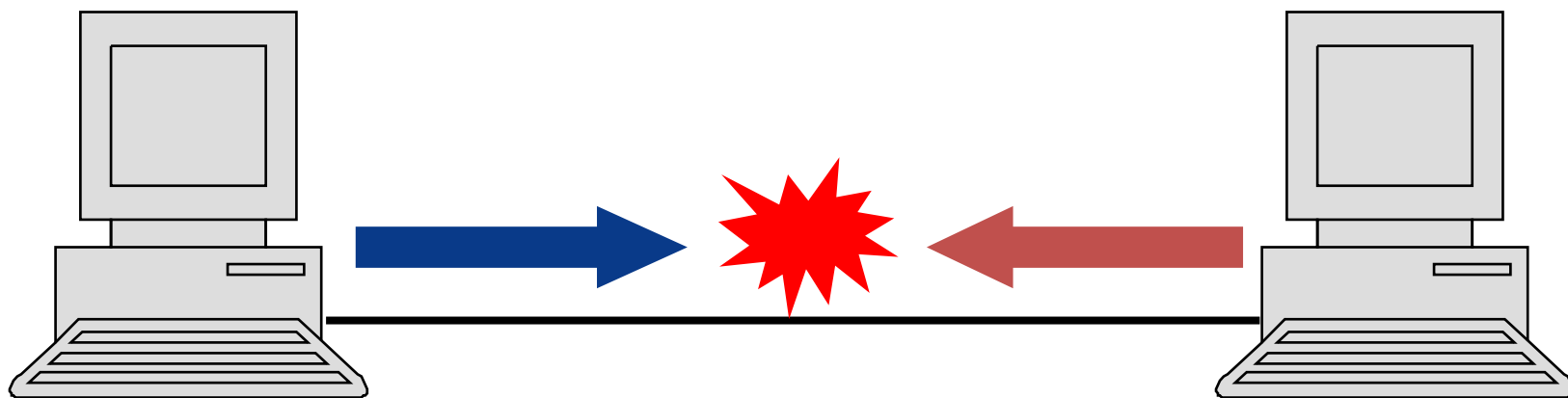

Data flow concepts

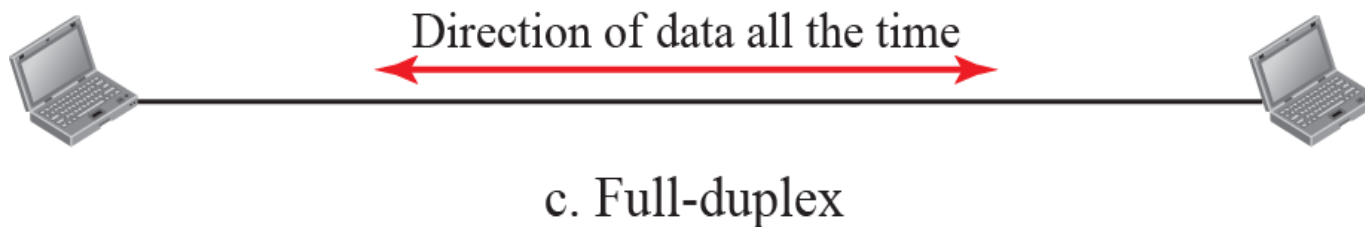
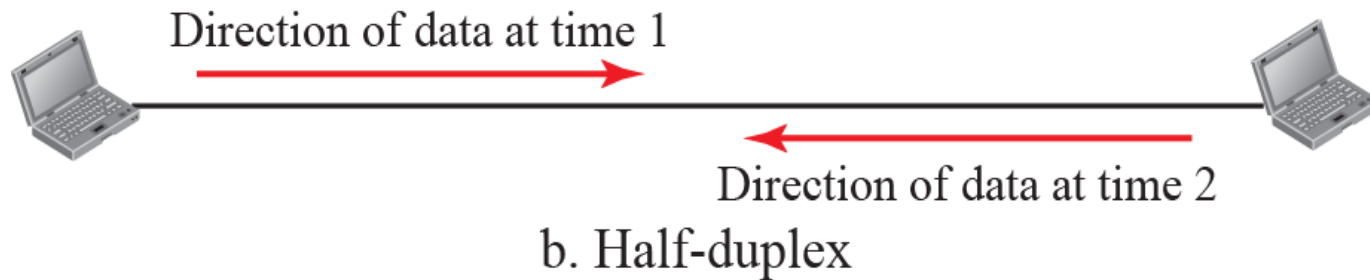
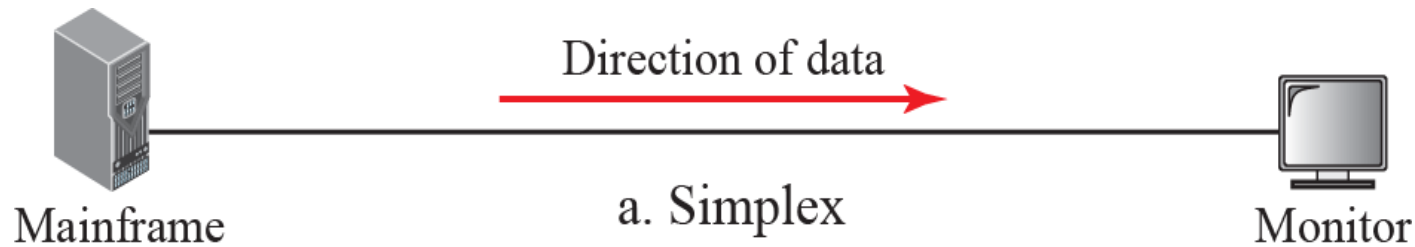

Multiplexing of links

- Physical links need to be shared.
- They are divided into several channels.

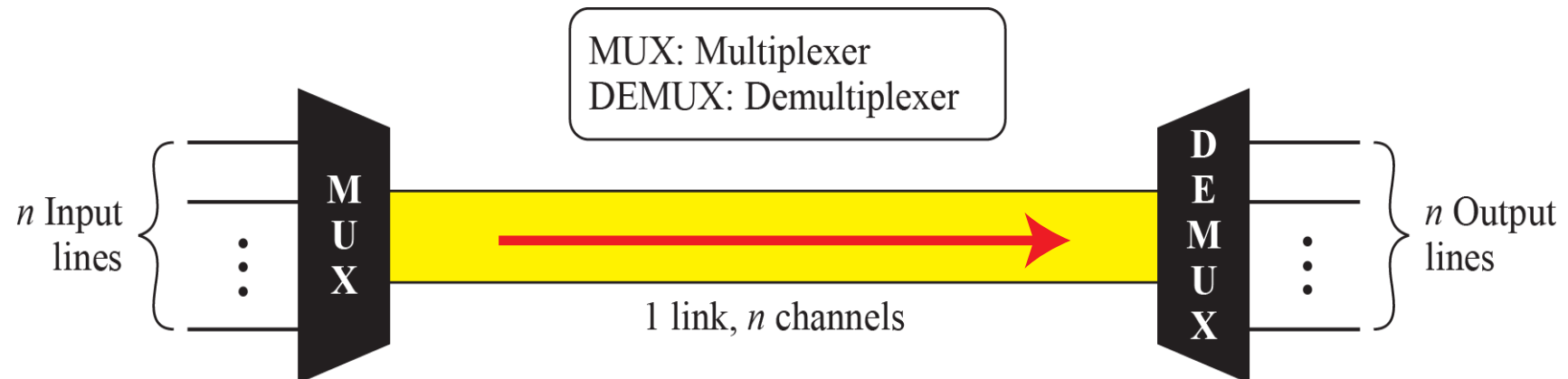

Multiplexing techniques

1. Space-Division multiplexing (SDM)
2. Frequency-Division Multiplexing (FDM)
3. Wavelength-Division Multiplexing (WDM)
4. Time-Division Multiplexing (TDM)
5. Code-Division Multiple Access (CDMA)

Space-Division Multiplexing (SDM)

- Used in fibre-optic cables
- Each channel uses one optical fibre.

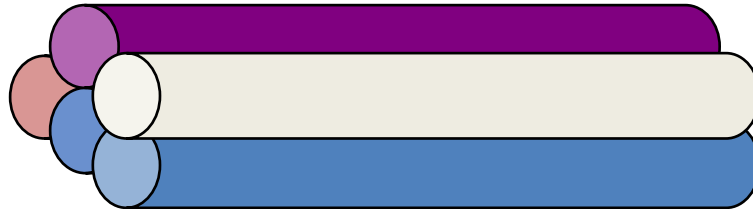

Frequency-Division Multiplexing (FDM)

- Analog multiplexing technique
- Physical link divided into frequency bands
- Each channel uses a unique carrier frequency.

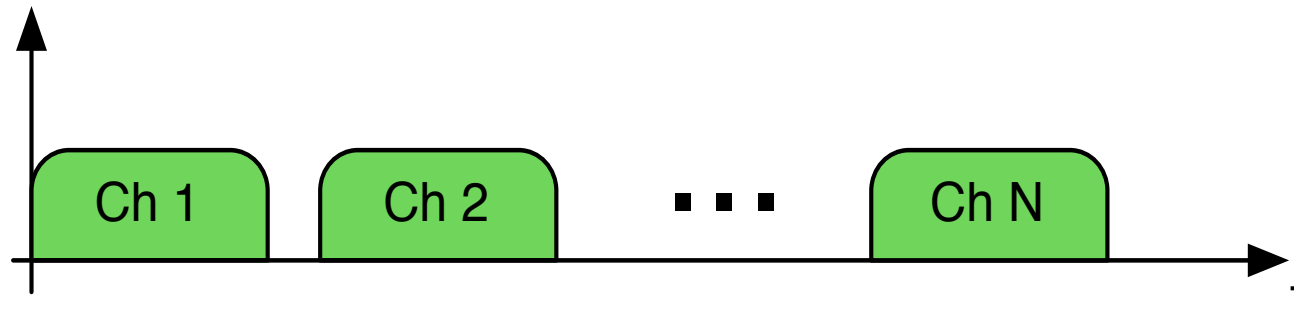

FDM process

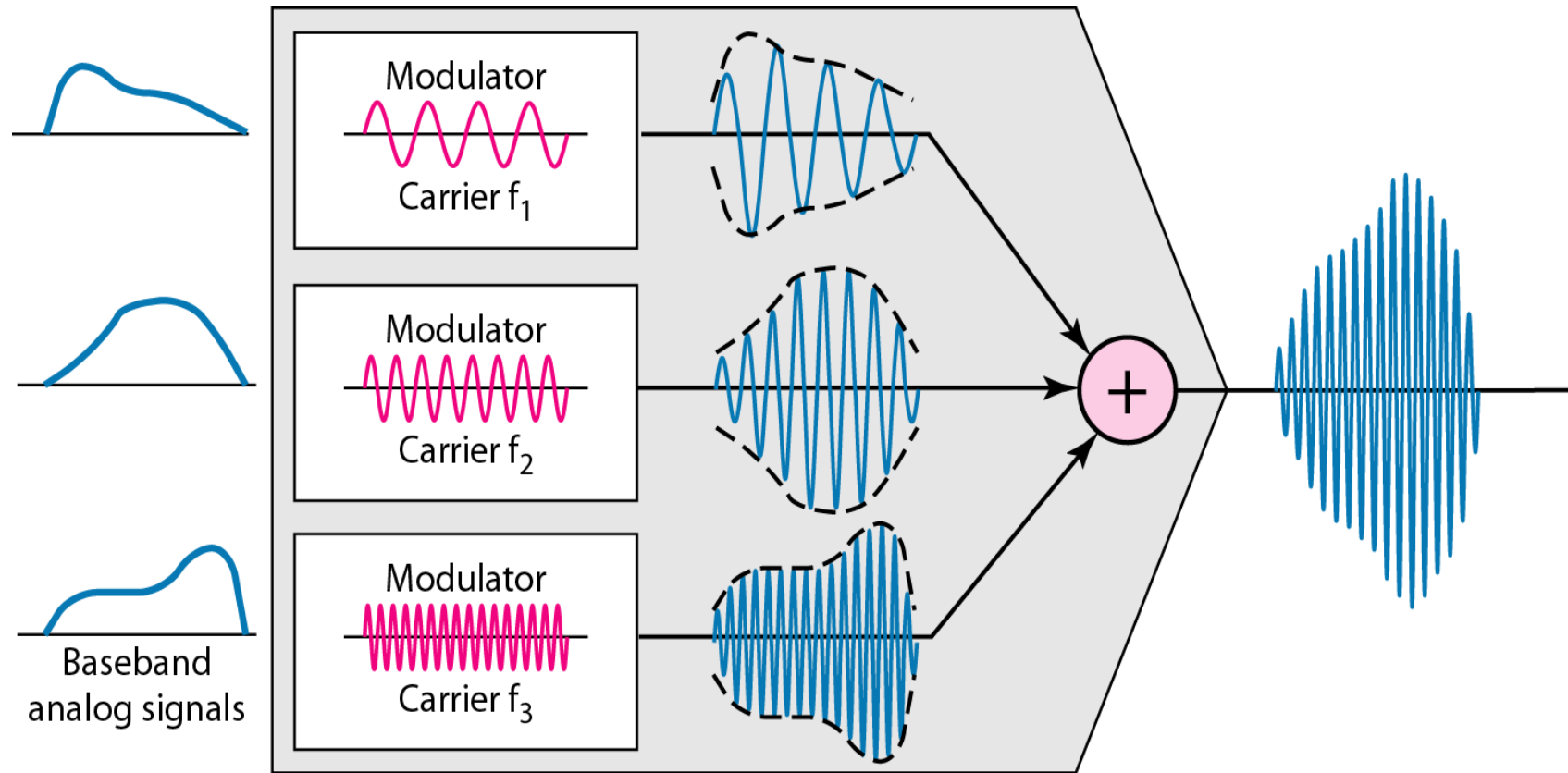

Wavelength-Division Multiplexing (WDM)

- Analog multiplexing technique
- Combines optical signals

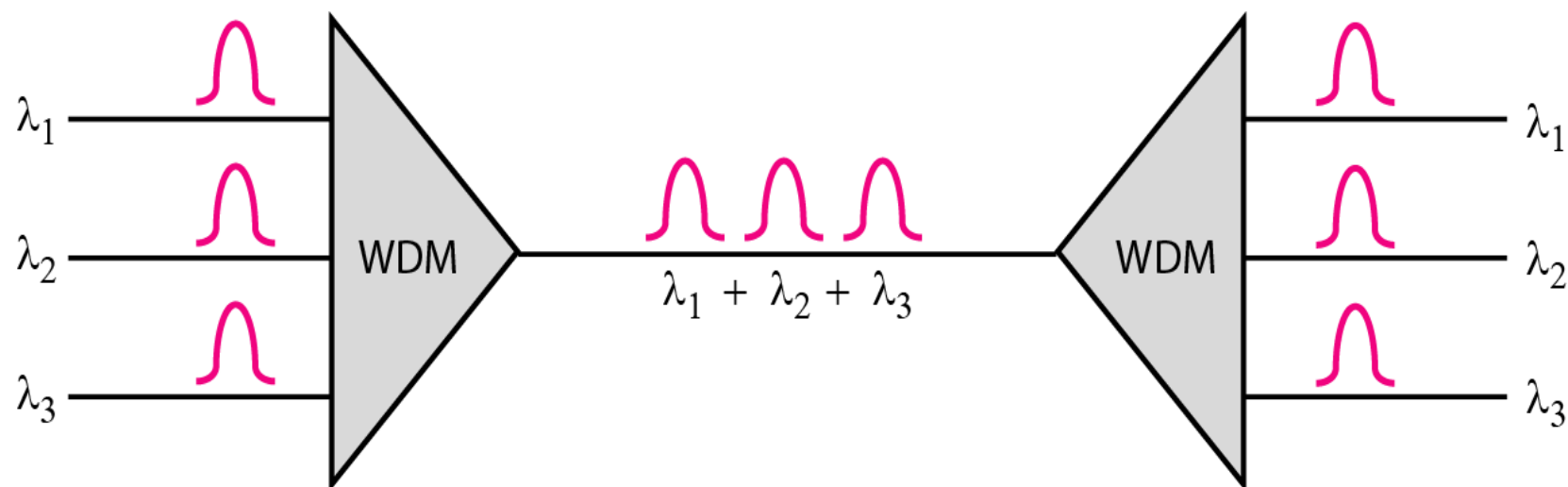

Time-Division Multiplexing (TDM)

- Each channel occupies a time slot on the link.

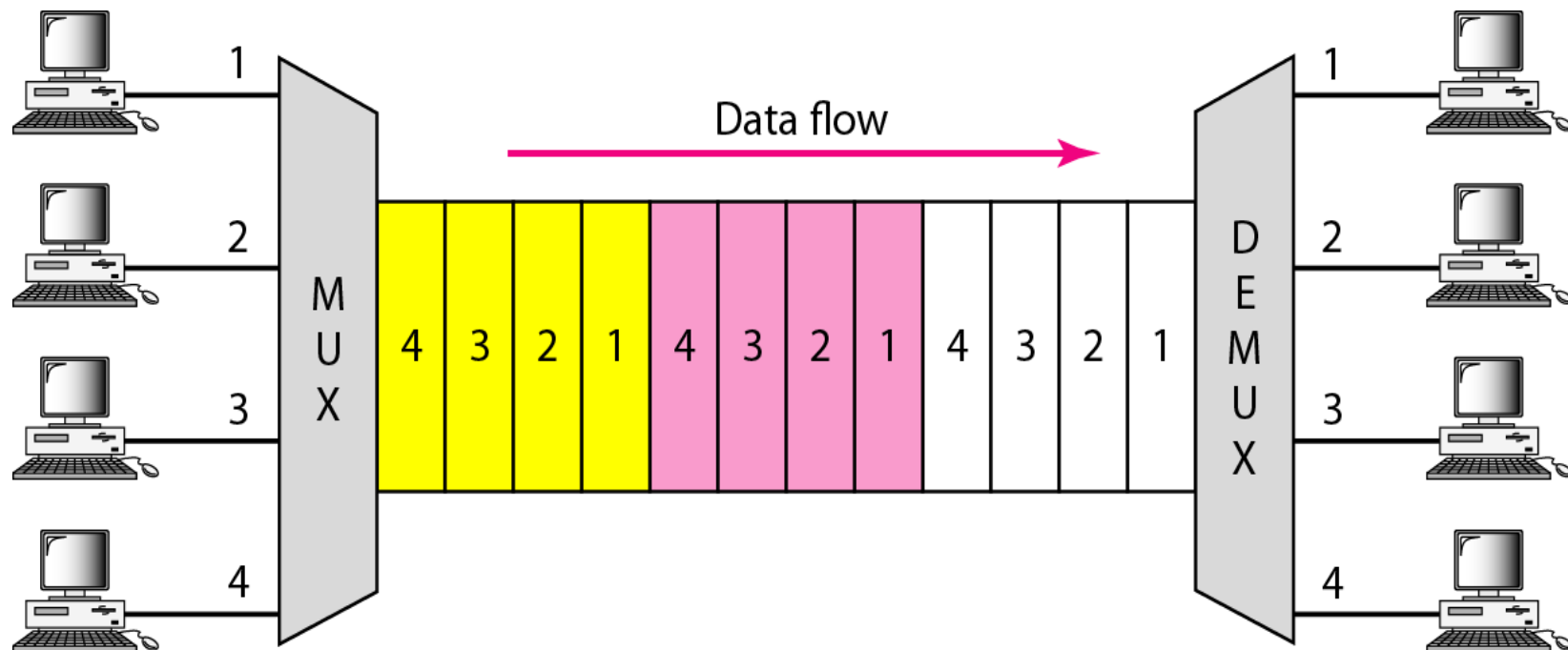

Synchronous TDM

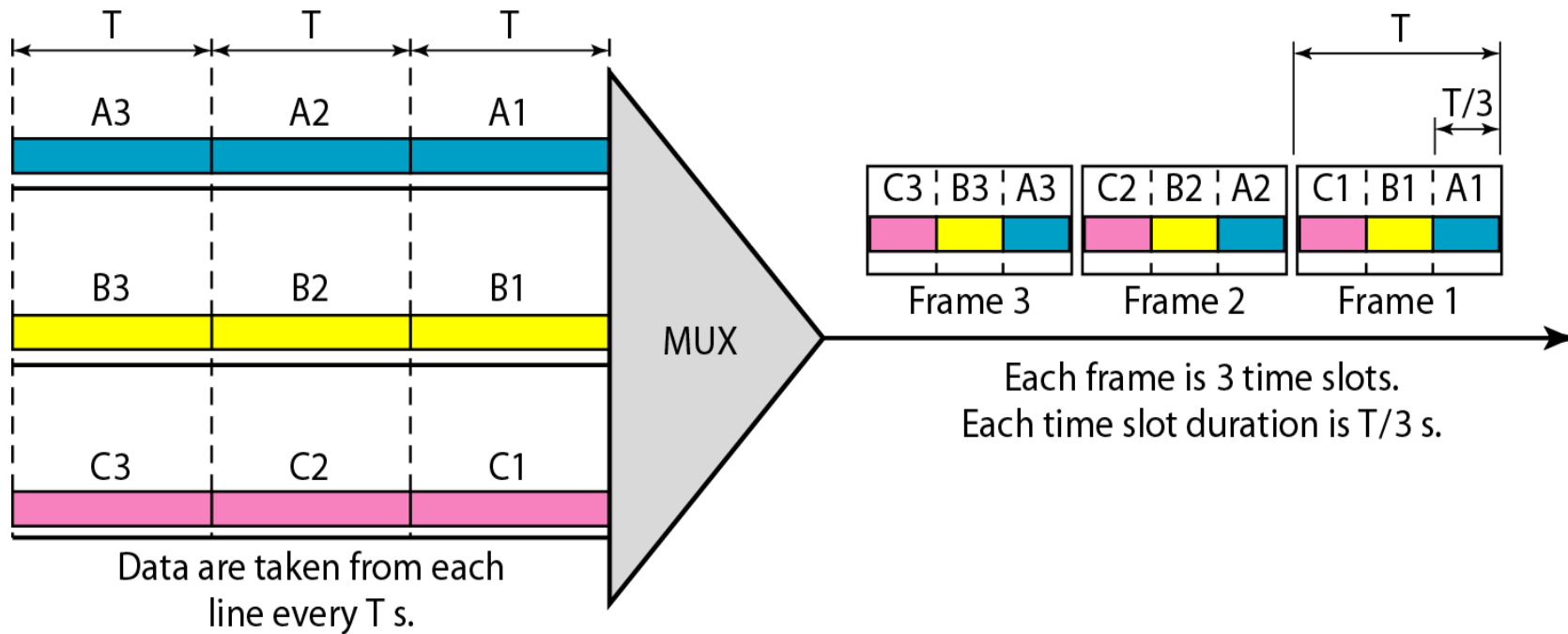

Synchronous TDM

- If a channel has nothing to send, its time slots will be empty!

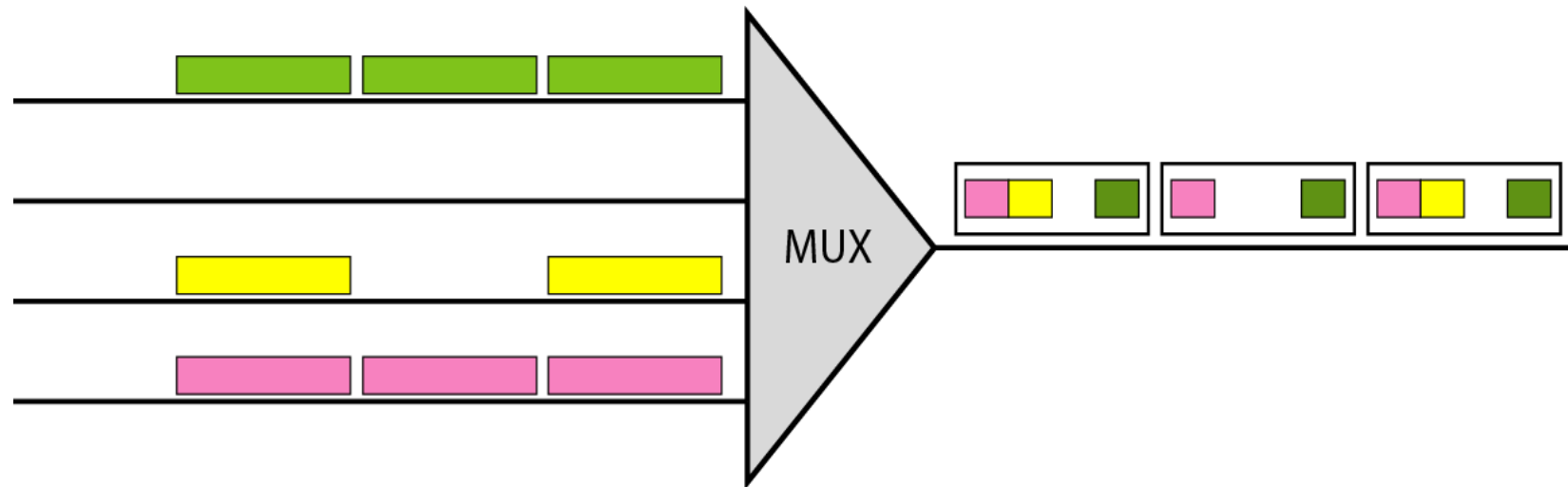

- Solution: Dynamic slot allocation

Statistical Time-Division Multiplexing

- Dynamic slot allocation
- No time slots reserved for channels
- Destination address added to each slot
- Better performance when not all channels transmit data all the time

TDM comparison

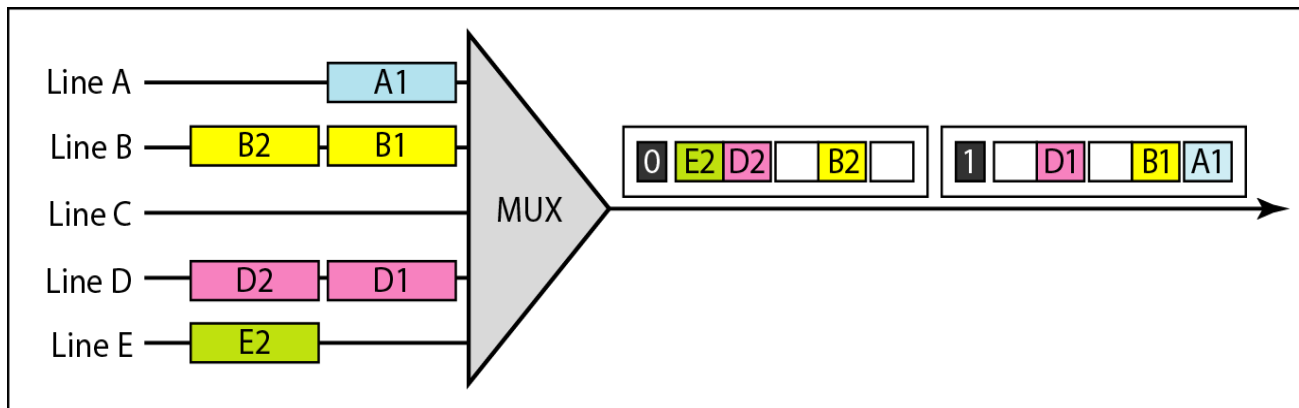

a. Synchronous TDM

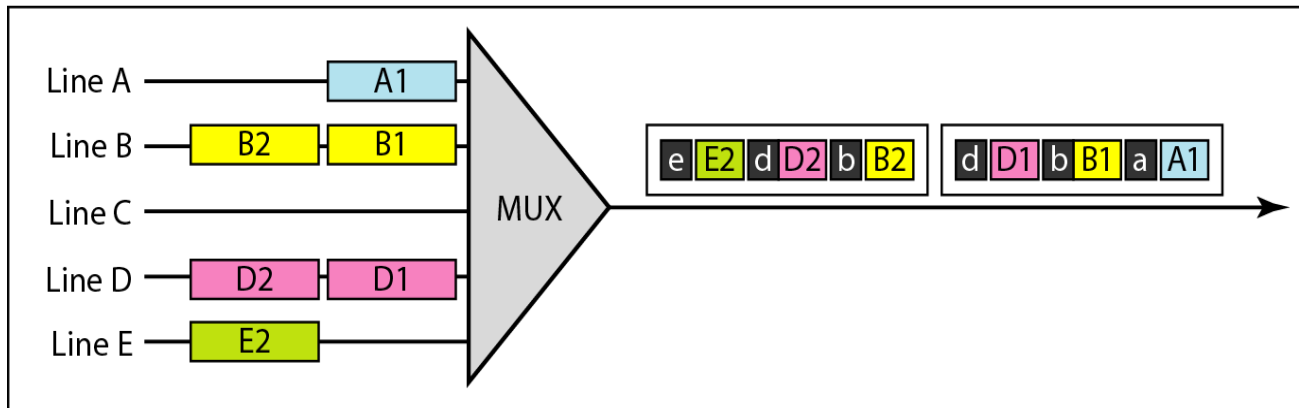

b. Statistical TDM

Summary: Physical Layer

- Data, signal → analog, digital
- Digitalisation
 - Sampling, quantisation, encoding
- Digital transmission → coding
- Analog transmission → modulation
 - Attenuation, distortion, noise
- Multiplexing
 - Space, frequency, wavelength, time